

Chapter 1

Creating Sketches in the Sketch Mode

Learning Objectives

After completing this chapter you will be able to:

- Use different SKETCHER options for creating a geometry.
- Dimension a sketch using the Normal option.
- Use the Mirror option in a sketch.
- Use the Intent Manager in a sketch.
- Modify a sketch.
- Use Modify Dimensions dialog box when you are using Intent Manager.
- Regenerate a sketch.
- Use drawing display options.



THE SKETCH MODE

Almost all the models designed in Pro/ENGINEER consists of datums, sketched features and placed features. Generally, for creating datums and placed features, you do not require sketches. However, to create a sketched feature, it is necessary to draw a two-dimensional (2D) sketch. When you enter the Part mode and select the options to create any sketched feature, the system automatically takes you to the sketcher environment. In the sketcher environment, the sketch of the feature is created and regenerated, and then you return to the Part mode to create the required feature. The sketches created in the Sketch mode are stored in **.sec** format. You will learn about the datums and placed features in later chapters.

The Sketch mode is used when the design of a product is at its development stage. The designer can sketch the 2D sketch of the product and assign required dimensions to it. By assigning the dimensions, the designer can make sure that the 2D sketch of the product or model is satisfying all the necessary conditions and then continue for the 3D model of the design, that is, the Part mode.

Using the Sketch Mode

To create any section in the Sketch mode of Pro/ENGINEER, certain basic steps have to be followed. The following steps outline the procedure to use the Sketch mode:

1. Sketch the required section geometry

The different sketcher tools available in this mode can be used to sketch the required section geometry.

2. Add the constraints and dimension the sketched section

After sketching the section geometry, the constraints and dimensions are added to the section. For dimensioning the section there are two options. Either the **AutoDim** option or the **DIMENSION** submenu options available in the **Menu Manager** can be used. If the **Intent Manager** is used for sketching then the sketch will be automatically dimensioned and constrained. After adding the dimensions you can modify them as required.

3. Add relations to the sketch

The geometry of various entities of the sketch can be controlled by adding relations.

4. Regenerate the section

After dimensioning the sketch, the sketch must be regenerated. Remember that the section is regenerated only if the minimum constraints of the sketch are satisfied. Pro/ENGINEER has the capability to analyze the section and if the section is not complete for any reason, the section will not be regenerated. However, Pro/ENGINEER makes certain assumptions to regenerate the section.

If the **Intent Manager** is on while sketching then the sketch is automatically regenerated.

Entering the Sketch Mode

To enter the Sketch mode select **New** from the **File** menu or choose the **Create a new object**

button from the **File** toolbar. The **New** dialog box will be displayed with different Pro/ENGINEER modes available. When you choose the **Sketch** radio button a default name of sketch file appears in the **Name** edit box. You can change the sketch name as required. Choose the **OK** button to enter the Sketch mode.

THE SKETCHER ENVIRONMENT

When you enter the Sketch mode, the initial screen appearance will be similar to the one shown in Figure 1-1. This figure also shows the **Sketcher Tools** toolbar. The buttons available in this toolbar are used to draw a sketch. When you enter the sketcher environment, by default the **Intent Manager** is on. It is recommended to use the **Intent Manager** only if you are an experienced user of this software. However, if you are a beginner, you should avoid using the **Intent Manager**. In later chapters of this book, you will learn to create sketches using the **Intent Manager**. You can turn off the **Intent Manager** by clearing the check mark on the left of the **Intent Manager** option that is available in the **Sketch** menu in the menu bar.

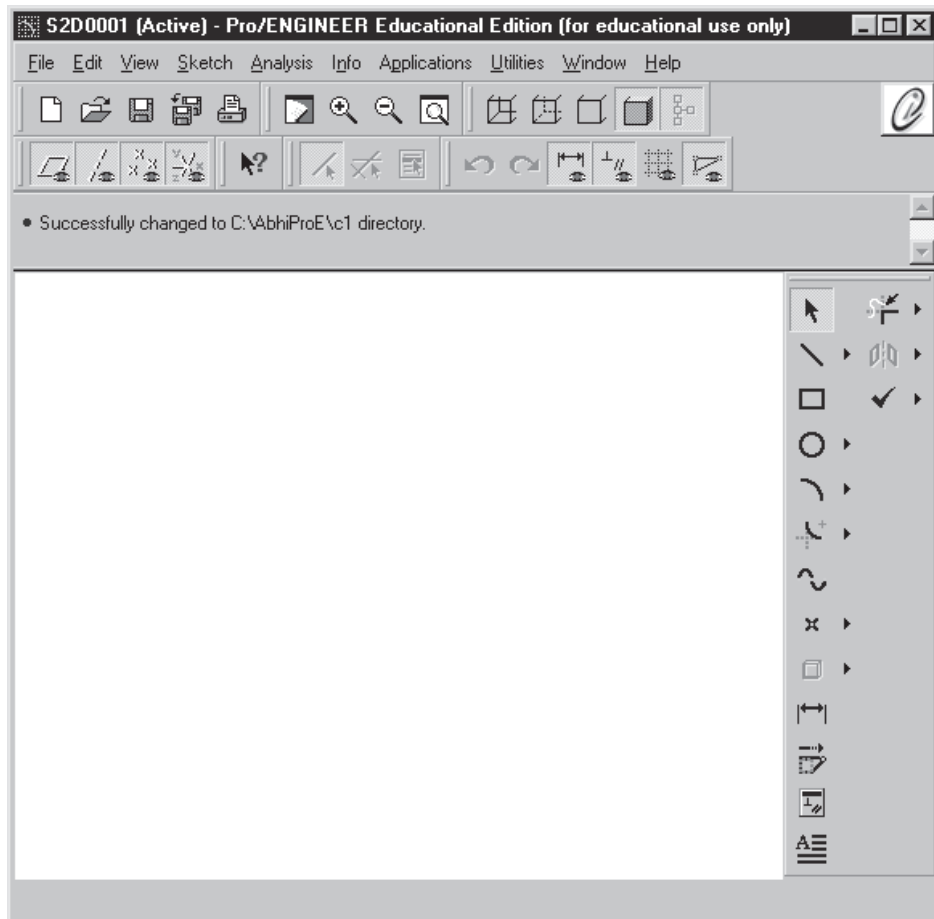
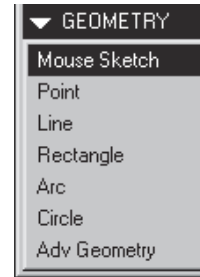

Figure 1-1 Initial screen appearance after entering the Sketch mode

CREATING A SKETCH IN THE SKETCH MODE

If the **Intent Manager** is off, by default the **Sketch** option is selected in the **SKETCHER** menu and the **Mouse Sketch** option is selected in the **GEOMETRY** submenu. You can start sketching either using the **Intent Manager** or without using it. When you are drawing a sketch using the **Intent Manager**, the **Sketcher Tools** toolbar is used. When you are not using the **Intent Manager** to draw a sketch, the **Menu Manager** is available with different sketcher options. The options available under the **GEOMETRY** submenu are shown in Figure 1-2. The section geometry can be sketched using these options and their functions are discussed next.



*Figure 1-2 GEOMETRY submenu options to draw a sketch with **Intent Manager** off*



Note

The sketch is saved as .sec file extension. While drawing in the Part mode if you save a drawing before regenerating it, the part is saved in the .sec file extension.

*In later chapters of this book you will create sketches using the **Intent Manager**. But, you should learn to draw sketches without using the **Intent Manager**. This is because the basics of creating sketches in Pro/ENGINEER are understood only when you draw sketches without using the **Intent Manager**.*

Drawing a Sketch Using the Mouse Sketch

Using the **Mouse Sketch** option you can create a desired section. You can draw lines, arcs that start at the endpoint of any existing geometry, and circles by using the three button mouse. The **Mouse Sketch** allows you to continuously draw a sketch without selecting the options from the **GEOMETRY** submenu in the **Menu Manager**. For example, you can draw a line, a circle, and an arc without selecting these options from the **GEOMETRY** submenu. The equivalent of the **Mouse Sketch** option is not available when the **Intent Manager** is on. The different entities that can be drawn using the **Mouse Sketch** option are discussed next.

Drawing a Line Using the Mouse Sketch

The following steps explain the procedure to sketch a line using the **Mouse Sketch** option:

1. Using the left mouse button, specify a point on the graphics screen from where you want the line to start. A red rubber-band line appears, one end of which is fixed at the point you specified and the other is attached to the cursor. Now, move the cursor on the screen to a desired point where you want the line to end.
2. Using the left mouse button specify the endpoint of the line. The line ends at this point. Note that line creation does not end at this point. The next rubber-band line will be attached to the cursor. The endpoint of the last line will be the start point of this new line. This process will continue until you terminate line creation.
3. Press the middle mouse button to end line creation. The lines drawn appear in cyan color and the red rubber-band line disappears.

**Note**

To draw a sketch, options are chosen from **Menu Manager** when the **Intent Manager** is off and buttons are chosen from toolbar when the **Intent Manager** is on.

It is recommended to use a three button mouse while working in Pro/ENGINEER. It becomes almost impossible to work with a two button mouse.

Drawing a Circle Using the Mouse Sketch

The following steps explain the procedure to sketch a circle using the **Mouse Sketch** option:

1. Specify the center of the circle you want to draw by pressing the middle mouse button on the graphics screen. A red rubber-band circle appears having its center at the specified point. The rubber-band circle is attached to the cursor.
2. You can now move the cursor away from the center point to give the circle a required size.
3. Once you get the appropriate size of the circle, press the middle mouse button. The circle appears in cyan color. However, if you want to abort the circle, you can do so by pressing the left mouse button.

Drawing an Arc Using the Mouse Sketch

When you draw an arc using the **Mouse Sketch** option, the arc is created tangent to the endpoint of an entity by default. The following steps explain the procedure to sketch an arc using the **Mouse Sketch** option:

1. Using the right mouse button, select the endpoint of an entity from where you want to start the arc. A red rubber-band arc appears with one end attached to the cursor and the other end tangent to the entity.
2. Now, move the cursor on the graphics screen to size the arc.
3. When you get the required size of the arc, use the right mouse button to complete the arc. A cyan colored arc is sketched. However, if you want to abort the arc, you can do so by pressing the middle mouse button.

**Note**

The color of the entities displayed depends on the system settings of the colors you set. The colors referred to above are the default system colors.

Drawing a Point

The following steps explain the procedure to sketch a point:

1. Choose **Sketch** from the **SKETCHER** menu and **Point** from the **GEOMETRY** submenu in the **Menu Manager**.



If the **Intent Manager** is on, choose the **Create points.** button available in the **Right Toolchest.** When you invoke this option, the system prompts you to select a location for the point on the graphics screen.

- As soon as you select a point using the left mouse button, the point is placed on the graphics screen at the desired location.

Drawing a Line

To create lines, choose **Sketch** from the **SKETCHER** menu and **Line** from the **GEOMETRY** submenu in the **Menu Manager.** The **LINE TYPE** submenu appears with different line options for drawing a line. Figure 1-3 shows the various options available in the **LINE TYPE** submenu.



If the **Intent Manager** is on, choose the **Create lines.** button available in the **Right Toolchest.**

You can create two types of lines using the **Line** option. They are **Geometry** and **Centerline.** The **Geometry** option is used to create section sketches. The **Centerline** option is used for creating center lines for revolved features, mirroring, and so on.

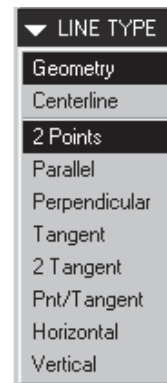

Figure 1-3 Different options in the **LINE TYPE** submenu



Note

When the **Intent Manager** is on, constraints are applied automatically to the entities you draw. Hence, the *parallel, tangent, and other options for drawing lines* are not required when the **Intent Manager** is on. This is the reason, these options are not available to draw lines when the **Intent Manager** is on.

If the **Intent Manager** is on and you press and hold down the right mouse button on the graphics screen, a shortcut menu is displayed as shown in Figure 1-4. This menu provides all the basic sketcher options that can be used to draw a sketch.

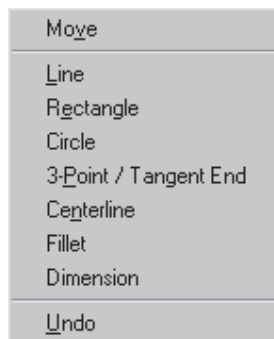

Figure 1-4 Shortcut menu that can be invoked when the **Intent Manager** is on

The procedures to create lines using the different **LINE TYPE** submenu options are

discussed next.

Drawing a Line Using the 2 Points Option

The following steps explain the procedure to create a line using the **2 Points** option:

1. Choose **SKETCHER > Sketch > Line > Geometry > 2 Points** from the **Menu Manager**. Select a point on graphics screen to start the line using the left mouse button. A red rubber-band line appears from the selected point with the other end attached to the cursor.
2. The system then prompts you to specify the endpoint. Move the cursor on the graphics screen to give the desired length to the line. Use the left mouse button to specify the endpoint of the line. The line appears in cyan color. However, the rubber-band line continues with the second line.
3. Repeat step 2 until all the lines are drawn. End line creation by pressing the middle mouse button. If you want to abort line creation, you can press the middle mouse button.

Drawing a Line Using the Parallel Option

You can use the **Parallel** option to create parallel lines. There must be a line drawn on the graphics screen to set the direction for creating the parallel line. The following steps explain the procedure to draw lines using the **Parallel** option:

1. Choose **SKETCHER > Sketch > Line > Geometry > Parallel** from the **Menu Manager**. You will be prompted to select a line to set the direction for the parallel line.
2. Using the left mouse button, select the line that will act as the reference line to set the direction for the parallel lines to be created. The color of the selected line changes from cyan to red.
3. You will be prompted to select the start point of the line. Specify the start point of the line using the left mouse button. A red rubber-band line appears that dynamically changes its length as you move the mouse. Move the mouse to size the line. Use the left mouse button to specify the endpoint of the line at the desired point. After creating the required number of parallel lines, press the middle mouse button to end line creation. The color of the line selected to set the direction changes from red to cyan.

Drawing a Line Using the Perpendicular Option

You can use this option for drawing perpendicular lines. There must be a line drawn on the graphics screen to set the direction for the perpendicular line. The following steps explain the procedure to draw lines using the **Perpendicular** option:

1. Choose **SKETCHER > Sketch > Line > Geometry > Perpendicular** from the **Menu Manager**. You will be prompted to select a line to which the new line will be perpendicular.
2. Using the left mouse button, select the line that you want to act as reference for the

perpendicular line. The color of this line changes from cyan to red.

3. You will be prompted to select the start point. A red rubber-band line appears as soon as you select the start point using the left mouse button. The size of this line changes dynamically as you move the mouse. Move the mouse to size the line. Use the left mouse button to specify the endpoint of the line at the desired point. After drawing the required number of perpendicular lines, press the middle mouse button. The color of the line selected to set the direction changes from red to cyan.

Drawing a Line Using the Tangent Option

You can use this option to draw a line tangent to an arc, a spline, or a conic. The following steps explain the procedure to draw lines using the **Tangent** option:

1. Choose **SKETCHER > Sketch > Line > Geometry > Tangent** from the **Menu Manager**. You will be prompted to select the endpoint of an entity.
2. Select the endpoint of an arc, conic, or a spline using the left mouse button. A red rubber-band line appears with a cursor. Move the cursor on the graphics screen to size the line. Press the left mouse button to specify the endpoint of the line. The red rubber-band line changes its color to cyan. The line is tangent to the entity selected.

Drawing a Line Using the 2 Tangent Option

The **2 Tangent** option is used to draw a tangent between two entities such as arcs, circles, splines, or a combination of these entities. The following steps explain the procedure to draw a tangent using the **2 Tangent** option:

1. Choose **SKETCHER > Sketch > Line > Geometry > 2 Tangent** from the **Menu Manager**. You will be prompted to select two different arcs, circles, or splines.
2. Select the first entity from where the tangent line will be drawn. The color of the entity changes to red. You will be prompted to select the second entity. As soon as you select the second entity, a line is drawn which is tangent to both the selected entities.



Note

It is not always possible to draw a tangent between two selected entities. If a tangent line is not possible, you are prompted to select set of entities to draw tangent lines.

Drawing a Line Using the Pnt/Tangent Option

You can use this option to draw a line tangent to any entity keeping one end of the tangent fixed. The following steps explain the procedure to draw a tangent using the **Pnt/Tangent** option:

1. Choose **SKETCHER > Sketch > Line > Geometry > Pnt Tangent** from the **Menu Manager**. You will be prompted to select a starting point.
2. Select the starting point of the line at the desired location on the graphics screen. This

point is fixed as one end of the line. You will be prompted to select an entity other than a line. As soon as you select the entity, a line will be drawn that is tangent to the entity selected.

Drawing a Line Using the Horizontal Option

The **Horizontal** option is used to create a horizontal line. Once you have finished drawing the horizontal line, the **Vertical** option is selected and you can continue to draw a vertical line. The following steps explain the procedure to draw horizontal lines using this option:

1. Select **SKETCHER > Sketch > Line > Geometry > Horizontal** from the **Menu Manager**. You will be prompted to select a start point.
2. Select the start point of the line. When you select the start point using the left mouse button, a red rubber-band line appears that changes its length dynamically as you move the cursor. Move the cursor on the graphics screen to size the line. Specify the endpoint of the line using the left mouse button. The red color of the line changes to cyan and a horizontal line is drawn. You will notice that a red rubber-band line starts again from the end of the last line in the direction normal to the previous line and in the **LINETYPE** submenu, the **Vertical** option is selected.
3. Continue step 2 until all the lines are drawn. Press the middle mouse button to end line creation. It must be noted that if you continue to draw lines using the **Horizontal** option then all the lines drawn will be perpendicular to each other. The selection in the **LINETYPE** submenu toggles between the **Horizontal** and **Vertical** options as you draw the lines.

Drawing a Line Using the Vertical Option

The **Vertical** option is used to create a vertical line. After the vertical line is drawn you can continue to draw a horizontal line. The following steps explain the procedure to draw vertical lines using this option:

1. Select **SKETCHER > Sketch > Line > Geometry > Vertical** from the **Menu Manager**. You will be prompted to select a start point. Specify the start point of the line.
2. A red rubber-band line appears that changes the size as you move the cursor. Size the line by moving the cursor on the graphics screen. Use the left mouse button to specify the endpoint of the line at the desired location. The red color of the line changes to cyan and a vertical line is drawn. You will notice that the **Horizontal** option is selected in the **LINETYPE** submenu and a red rubber-band line starts again from the endpoint of the last line in the perpendicular direction. You can use this line to create a horizontal line.
3. Continue step 2 until all the lines are drawn. Press the middle mouse button to end line creation. It must be noted that if you continue to draw lines using the **Vertical** option then all the lines drawn will be perpendicular to each other. The selection in the **LINETYPE** submenu toggles between the **Horizontal** and **Vertical** options as the lines are drawn.

The second option in the **LINE TYPE** submenu is **Centerline**. You can use the **Centerline** option in a similar way to draw lines as the **Geometry** option discussed earlier. As the name

implies, the lines drawn using this option are the center lines, the only difference is that you cannot create center lines continuously. This is because you do not require to draw center lines continuously.

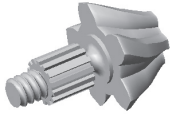

Tip: If you want to create only horizontal lines then create one horizontal line using the **Horizontal** option and press middle mouse button. Now, you are prompted to specify the start point for creating a horizontal line. Select the start point and then select the endpoint. Again press middle mouse button to create another horizontal line without creating a vertical line. Follow the same procedure to create only vertical lines.

Drawing a Rectangle

The following steps explain the procedure to sketch a rectangle using the **Rectangle** option:



If the **Intent Manager** is on, choose the **Create rectangle.** button available in the **Right Toolchest** to create a rectangle.

1. Choose **SKETCHER > Sketch > Rectangle** from the **Menu Manager**. You will be prompted to select two points to indicate the diagonal of box. Select the first point.
2. As you select the first point using the left mouse button, a red rubber-band box appears with the cursor attached to the opposite corner of the box. Move the cursor on the graphics screen to the desired location to size the diagonal of the rectangle. Use the left mouse button to select the second point for the diagonal of the rectangle. The red color automatically changes to cyan on selection of the second point for the diagonal.

Drawing an Arc

To draw an arc, choose **Sketch** from the **SKETCHER** menu and **Arc** from the **GEOMETRY** submenu in the **Menu Manager**. When you choose the **Arc** option, the **ARC TYPE** submenu appears with the different options. Figure 1-5 show different arc options in the **ARC TYPE** submenu.

Figure 1-6 shows the buttons available to draw arcs when the **Intent Manager** is on.

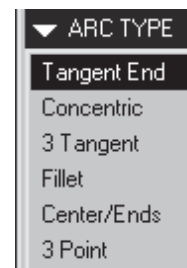

Figure 1-5 The different options in the **ARC TYPE** submenu

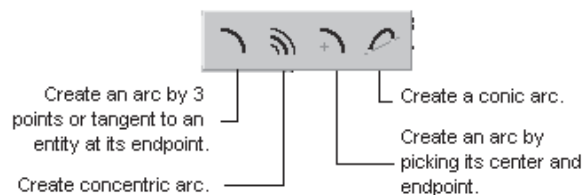

Figure 1-6 Arc options available when the **Intent Manager** is on

The procedure to draw arcs using different options in the **ARC TYPE** submenu are discussed next.

Drawing an Arc Using the Tangent End Option

The **Tangent End** option is used to draw arcs that are tangent to any entity. The following steps explain the procedure to draw arcs using the **Tangent End** option:

1. Choose **SKETCHER > Sketch > Arc > Tangent End** from the **Menu Manager**. You will be prompted to select an endpoint of an entity to determine tangency.
2. As soon as you select the endpoint of an entity, a red rubber-band arc appears with one end attached to the entity and the other end attached to the cursor. Move the cursor on the graphics screen to the desired position to size the arc. Use the left mouse button to complete the arc. The red color of the rubber-band arc changes to cyan.

All the arcs created by using this option are tangent to the selected entities. To abort arc creation press the middle mouse button.

Drawing an Arc Using the Concentric Option

The **Concentric** option is used to draw an arc concentric to the other arc. You will have to select an entity to which the arc will be concentric. The entity selected must be an arc or a circle. The following steps explain the procedure to draw an arc using the **Concentric** option:

1. Choose **SKETCHER > Sketch > Arc > Concentric** from the **Menu Manager**. You will be prompted to select an entity to determine the center of the arc to be created. The entity to be selected should be an arc or a circle.
2. As soon as you select an entity, you are prompted to select the start point of the arc. Select the start point of the arc. A red rubber-band arc will appear with one end attached to the start point. The size of the arc will change as you move the cursor. Move the mouse to size the arc. You will be prompted to select the endpoint of the arc. As soon as you select the end point of the arc, the red color of the rubber-band arc changes to cyan.
3. Repeat step 2 until you draw the required number of arcs. You can end arc creation by pressing the middle button of the mouse.

Drawing an Arc Using the 3 Tangent Option

The **3 Tangent** option is used to draw a tangent which is passing through three entities. The following steps explain the procedure to draw an arc using the **3 Tangent** option:

1. Choose **SKETCHER > Sketch > Arc > 3 Tangent** from the **Menu Manager**. You will be prompted to select the first entity to which the arc will be tangent.
2. As soon as you choose the first entity the color of the entity changes to red. Now, you will be prompted to select the second entity. When you choose the second entity, its color also changes to red. Similarly, select a third entity. An arc is created instantly when all the three entities are selected. The arc drawn is tangent to all the three entities selected.
3. Repeat step 2 until you draw the required number of arcs. If you want to abort arc creation, you can use the middle mouse button.

Drawing an Arc Using the Fillet Option

The **Fillet** option is used for drawing arcs with fillets between two entities. The following steps explain the procedure to draw fillet arcs:

1. Choose **SKETCHER > Sketch > Arc > Fillet** from the **Menu Manager**. You will be prompted to select the two entities.
2. Select the first entity for filleting using the left mouse button. The cyan color of the first entity changes to red. Now, select the second entity. As soon as you select the second entity, a possible fillet is drawn between the two entities selected.
3. Repeat step 2 until the required number of possible fillets are drawn.



Note

You can draw fillet between any two entities except between two parallel lines.

Drawing an Arc Using the Center/Ends Option

The following steps explain the procedure to draw an arc using the **Center/Ends** option:

1. Choose **SKETCHER > Sketch > Arc > Center/Ends** from the **Menu Manager**. You will be prompted to select the center of the arc.
2. Using the left mouse button, select a center point for the arc on the graphics screen. A red colored center mark appears at that point on the graphics screen. Now, you are prompted to select the start point of the arc. Select the start point of the arc at the desired location. A red rubber-band arc appears from the start point. The size of this arc changes dynamically as you move the mouse.
3. You will be prompted to select the endpoint of the arc. Move the mouse to size the arc, and then select the endpoint of the arc using the left mouse button. An arc is drawn between the two points selected.

Note that you can draw only one arc with one center. If you want to draw another arc you will have to select the center again.

Drawing an Arc Using the 3 Point Option

The **3 Point** option is used to draw an arc by specifying three points on the graphics screen. The following steps explain the procedure to draw an arc using the **3 Point** option:

1. Choose **SKETCHER > Sketch > Arc > 3 Point** option from the **Menu Manager**. You will be prompted to select the start point of the arc.
2. Select the start point of the arc using the left mouse button at any point on the graphics screen. As you select the start point, a red rubber-band line appears with one end attached to the start point and the other to the cursor.

3. Next, you are prompted to select the endpoint of the arc. Move the mouse to size the arc at the desired location on the graphics screen. Select the endpoint of the arc using the left mouse button. A red rubber-band arc appears between the two selected points. The cursor is attached to the arc and you can move the cursor in between the start point and the endpoint to size the arc.
4. Next, you are prompted to select the third point. Choose the third point after moving the mouse on the graphics screen using the left mouse button. The red rubber-band arc changes its color to cyan and the arc is drawn.

Drawing a Circle

To draw a circle, choose **Sketch** from the **SKETCHER** menu and **CIRCLE** from the **GEOMETRY** submenu in the **Menu Manager**. When you choose the **CIRCLE** option, the **CIRCLE TYPE** submenu is displayed with different options as shown in Figure 1-7.

You can draw two types of circles using the **CIRCLE** option. They are **Geometry** and **Construction**. The procedure to draw circles using the different **CIRCLE TYPE** submenu options is discussed next.

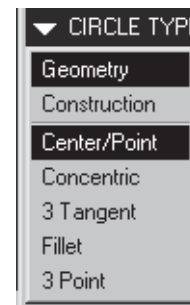

Figure 1-7 The various options in the CIRCLE TYPE submenu

Drawing a Circle Using the Center/Point Option

The **Center/Point** option is used to draw a circle by defining its center.



The **Create a circle by picking the center and a point on the circle.** button can be used when you are using the **Intent Manager**. This button is not available when the **Intent Manager** is off. The following steps explain the procedure to draw a circle using the **Center/Point** option:

1. Choose **SKETCHER > Sketch > Circle > Geometry > Center/Point** from the **Menu Manager**. You are prompted to select the center of the circle.
2. Specify the center point for the circle on the graphics screen using the left mouse button.
3. You are prompted to select a point on the circle to complete it. A red rubber-band circle appears with the center at the specified point and the cursor attached to it. Move the cursor to size the circle. Use the left mouse button to complete circle creation. You will again be prompted to select the center of the circle.
4. Repeat steps 2 and 3 until you draw all the required circles. If you want to abort circle creation before completing it, press the middle mouse button.

Drawing a Circle Using the Concentric Option

The following steps explain the procedure to draw a circle using the **Concentric** option:



The **Create concentric circle** button can be used to draw a concentric circle when you are using the **Intent Manager**. However, if the **Intent Manager** is off then this button is not available.

1. Choose **SKETCHER > Sketch > Circle > Geometry > Concentric** from the **Menu Manager**. You will be prompted to select an arc to determine the centre. You can select an arc or a circle to use the center point.
2. Using the left mouse button, select an arc or a circle to determine the concentricity of the circle to be drawn. You will be prompted to use the left mouse button to start dragging the circle diameter. Select a point on the screen to start drawing the circle.
3. After sizing the circle you can finish circle creation using the left mouse button. Repeat step 2 until all the concentric circles are drawn. Press the middle mouse button to end circle creation or to abort it.

Drawing a Circle Using the 3 Tangent Option

The **3 Tangent** option is used to draw a circle that is tangent to three other entities. This option uses the reference entities to draw a circle. The circle drawn using this option is drawn irrespective of the points selected on the entity. The following steps explain the procedure to draw a circle using the **3 Tangent** option:

1. Choose **SKETCHER > Sketch > Circle > Geometry > 3 Tangent** from the **Menu Manager**. You will be prompted to select the first entity.
2. Choose the first entity using the left mouse button. The color of the entity changes to red. Similarly, you are prompted to select the second and the third entities. As you select all the three entities, a circle is drawn that is tangent to all the three entities. You are again prompted to select the first entity for the second circle if required to be drawn.
3. Repeat step 2 until you draw all the circles. To end the creation of circle using this option or to abort it, press the middle mouse button.

Drawing a Circle Using the Fillet Option

The **Fillet** option is used to draw a circle that is tangent to two entities. You will be prompted to select two entities to draw a fillet circle. If the points selected on the entities do not satisfy the constraints for the fillet to be drawn, you will get an error message for the invalid selection. Then you will be again prompted to select the two entities to draw a circle using the **Fillet** option. The following steps explain the procedure to sketch a circle using this option:

1. Choose **SKETCHER > Sketch > Circle > Geometry > Fillet** from the **Menu Manager**. You will be prompted to select the first entity.
2. Select the first entity using the left mouse button. The color of the entity changes to red. Then you are prompted to select the second entity. When the second entity is selected, a circle is drawn that is tangent to both the entities. You will again be prompted to select the first entity for the creation of the second circle.

- Repeat step 2 until you draw the required number of circles. Press the middle mouse button to end the creation of the circle or if you want to abort circle creation before the circle is completed.

**Note**

It is possible to draw a fillet circle between two parallel lines.

Drawing a Circle Using the 3 Point Option

The following steps explain the procedure to draw a circle using the **3 Point** option:

- Choose **SKETCHER > Sketch > Circle > Geometry > 3 Point** from the **Menu Manager**. You will be prompted to specify the first point on the circle.
- Using the left mouse button, select the first point at the desired location on the graphics screen. A red rubber-band line appears with the cursor attached to one end of the line and you will be prompted to select the second point. Move the cursor on the graphics screen to select the second point.
- As soon as you select the second point, a red rubber-band circle appears with the cursor attached to it. You are prompted to select the third point. Move the mouse to size the circle. A circle is drawn when you select the third point using the left mouse button. You will again be prompted to select the first point on the circle to draw the next circle.
- Repeat step 2 until you draw all the circles. Press the middle mouse button to end circle creation or to abort circle creation before the circle is completed.

DIMENSIONING THE SKETCH

After you draw a sketch, the next step involves the dimensioning of the sketch. The basic purpose of dimensioning in Pro/ENGINEER is to control the size of sketch and to locate it with some reference. In Pro/ENGINEER, a sketch cannot be regenerated until and unless it is fully dimensioned and constrained.



When the **Intent Manager** is on, the entities are dimensioned and constrained automatically. The **Create defining dimension.** button is used to dimension the entities when the **Intent Manager** is on.

When the **Intent Manager** is off, the dimensions and constraints are not automatically applied. You need to manually add the dimensions by choosing the **Dimension** option from the **SKETCHER** menu. A **DIMENSION** submenu appears with different options to dimension the sketch. Figure 1-8 shows different options in the **DIMENSION** submenu. The **Normal** option is discussed next.

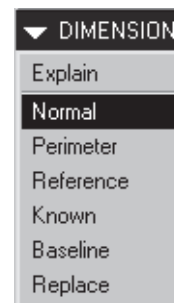

Figure 1-8 The different options of the **DIMENSION** submenu

Dimensioning a Sketch Using the Normal Option

The **Normal** option is used for normal dimensioning of the sketch. The following steps explain the procedure to dimension a sketch using the **Normal** option:

1. The **Normal** option is selected by default in the **DIMENSION** submenu in the **Menu Manager**. Select the entity you want to dimension by pressing the left mouse button. The color of the entity changes from cyan to red.
2. Place the dimension by pressing the middle mouse button at the desired place. The dimension appears in symbols such as sd0, sd1, and so on in yellow color. You can modify the dimension values using the **Modify** option discussed later in this chapter.

The remaining options in the **DIMENSION** submenu are discussed in Chapter 2.

WORKING WITH CONSTRAINTS

In Pro/ENGINEER, the entities in a sketch have to be fully specified in terms of size, shape, orientation, and location. This is achieved by setting constraints. Using constraints in the sketch reduces the number of dimensions in that sketch. Constraints are the logical operations that are performed on the selected geometry to make it more accurate in defining its position with respect to the other geometry. For example, if a line is very nearly parallel to another line then Pro/ENGINEER constrains the line as parallel to the other line. You can apply constraints manually only when the **Intent Manager** is on. You cannot manually apply the constraints after sketching the entities when the **Intent Manager** is off. There are two types of constraints in Pro/ENGINEER, **Geometry** constraints and **Assembly** constraints. Here, you will learn about the **Geometry** constraints and the **Assembly** constraints are discussed in later chapters.



When the **Intent Manager** is on, choose the **Impose sketcher constraints on the section.** button from the **Right Toolchest** to display the **Constraints** dialog box. This dialog box is shown in Figure 1-9.

This dialog box is used to apply constraints manually. Although when the **Intent Manager** is on, as you draw the sketch the constraints are applied automatically. Yet if you want to apply the constraints manually you can use this dialog box. The constraints that are applied automatically are weak constraints. Weak constraints appear gray in color. Weak constraints can be made strong. This is discussed later in this chapter. The various options in the **Constraints** dialog box are discussed next.



Figure 1-9 Constraints dialog box

Make line or two vertices vertical



This constraint forces the selected line segment to become a vertical line. This constraint also forces the two vertices to be placed along a vertical line.

Make line or two vertices horizontal



This constraint forces the selected line segment or two vertices that are apart by some distance to become horizontal or to lie in a horizontal line.

Make two entities perpendicular



This constraint forces the selected entity to become normal to another selected entity.

Make two entities tangent



This constraint forces the two selected entities to become tangent to each other. You are prompted to select two entities that you want to make tangent to each other.

Place point on the middle of the line



This constraint forces a selected point or vertex to lie on the middle of a line.

Create same points, points on entity or collinear constraint



This constraint performs three functions. This constraint can be used to force the two selected points to become coincident, to constraint a point on the selected entity, and to make two selected entities collinear, so that they lie on the same line. This constraint aligns two vertices or entities.

Make two points or vertices symmetric about a centerline



This constraint makes a section symmetrical about the centerline. When you select this constraint, you are prompted to select a centerline and two vertices to make them symmetrical.

Create Equal Lengths, Equal Radii, or Same Curvature constraint



This constraint forces any two selected entities to become of equal dimension. When you select this constraint, you are prompted to select two lines, arcs, circles, or ellipses to make their radii equal.

Make two lines parallel



This constraint is used to force two lines to become parallel. When selected, this constraint prompts you to select two entities that you want to make parallel. The two selected entities become parallel to each other.

When the **Intent Manager** is off and you choose the **Constraints** option from the **SKETCHER** menu, the **CONSTRAINTS** submenu is displayed as shown in the Figure 1-10. The options available under the **CONSTRAINTS** submenu when the **Intent Manager** is off are discussed next.

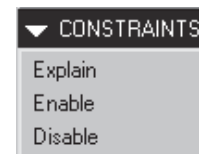

Figure 1-10 **CONSTRAINTS** submenu

Explain Option

The **Explain** option of the **CONSTRAINTS** submenu provides information about the constraints that are applied to a sketch. The constraints in the sketch are displayed as symbols. When you select the **Explain** option, you are prompted to select the constraint symbol on which you want the explanation. Select the symbol using the left mouse button. The information about the selected constraint is displayed in the **Message Area**.

This option is generally helpful when you view a sketch drawn by some other person. By using the **Explain** option you can obtain information about the different constraints applied in the sketch.

Enable Option

The **Enable** option when selected enables the selected constraints in the sketch. This option is used mainly after disabling the constraints using the **Disable** option that is discussed next.

Disable Option

The **Disable** option under the **CONSTRAINTS** submenu is used to disable the selected constraints. This is mainly used when you have to modify a sketch. For example, if two circles drawn appear of same size to Pro/ENGINEER, it assigns the same dimension to both the circles by applying the radius constraint. If after regenerating the sketch, the dimension of one of the circles is modified, the dimension of the other circle is automatically changed. Here you need the **Disable** option. By disabling the radius constraint of the circle, you can modify the dimension of the required circle without affecting the dimension of the other circle.

A constraint can be disabled using the left mouse button. When you select a constraint symbol to disable, a red \ line appears across the symbol.

Converting a Weak Constraint into a Strong Constraint when the Intent Manager is On

As discussed earlier, when you draw a sketch with the **Intent Manager** on, some weak dimensions are automatically applied to the sketch. As you proceed to complete the sketch, these dimensions are automatically deleted from the sketch without any confirmation.

Choose a weak dimension or weak constraint from the graphics screen. The selected dimension or constraint is highlighted in red. Choose **Edit > Convert To > Strong** from the menu bar. The color of the selected dimension is changed from gray to yellow, indicating that the selected constraint or dimension is made permanent.

DIFFERENCE IN WORKING WITH AND WITHOUT THE INTENT MANAGER

1. With the **Intent Manager** on, the sketch is automatically dimensioned. Without **Intent Manager**, the **Dimension** option in the **SKETCHER** menu is used to dimension the sketch.
2. With **Intent Manager** on, the constraints are applied automatically to the sketch while

drawing and are displayed at the same time. Without **Intent Manager**, the constraints are applied while drawing the sketch but are displayed after the regeneration of the sketch based on the assumptions made by Pro/ENGINEER.

3. With **Intent Manager** on, you cannot use the three functions of the three button mouse to draw a line, circle, and arc. Without **Intent Manager**, you can use the three mouse button to draw a line, circle, and arc.



Note

*Although a sketch is automatically dimensioned when the **Intent Manager** is on, yet it is very important to learn the procedure to dimension different entities in a sketch.*

DIMENSIONING THE BASIC SKETCHER ENTITIES

The procedure to dimension the sketcher entities such as arcs, circles, revolved sections, and so on when the **Intent Manager** is off is discussed next.

Dimensioning an Arc

Figure 1-11 explains the method of dimensioning an arc. Select both the ends of the arc using the left mouse button and then select a point on the arc. Next, place the dimension by using the middle mouse button at the desired point. The symbolic dimension appears as shown in the Figure 1-11. You can modify the dimension by using the **Modify** option that is discussed later.

Diameter Dimensioning

Figure 1-12 shows the diameter dimensioning technique. For diameter dimensioning, select the entity twice using the left mouse button. Then place the dimension by using the middle mouse button at the desired place. The diameter dimension appears in the symbolic form as shown in Figure 1-12. You can modify the dimension using the **Modify** option from the **Menu Manager**. The same diameter dimensioning technique is also used for arcs.

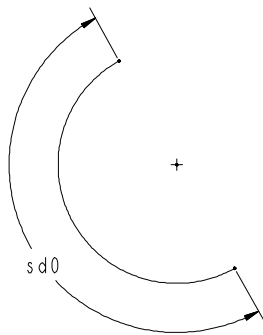

Figure 1-11 Arc dimensioning technique

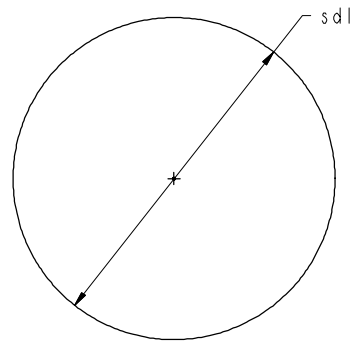

Figure 1-12 Diameter dimensioning technique

Radial Dimensioning

Figure 1-13 shows the radial dimensioning technique. For radial dimensioning, select the

entity once using the left mouse button. Then place the dimension by using the middle mouse button at the desired location. The radial dimension appears in the symbolic form as shown in Figure 1-13. You can modify the dimension using the **Modify** option.

Dimensioning Revolved Sections

Figure 1-14 shows the dimensioning technique for revolved sections. The need for revolving a section is discussed in the later chapters of this book. Here you will just learn how to dimension a revolved section. To dimension a revolved section select the entity to be dimensioned using the left mouse button. Select the centerline about which you want the section to be revolved. Using the left mouse button, once again select the original entity that you want to dimension. Now, place the dimension by pressing the middle mouse button at the desired location. The dimension appears in the symbolic form as shown in Figure 1-14. This dimension represents the diameter of a revolved section. You can modify the dimension by using the **Modify** option.

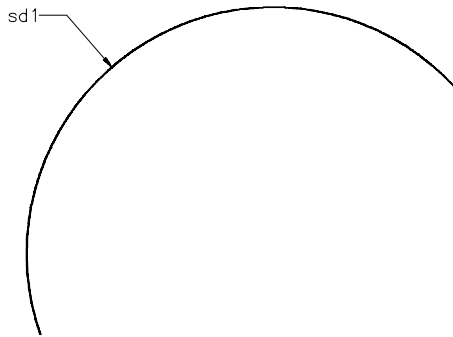

Figure 1-13 Radial dimensioning technique

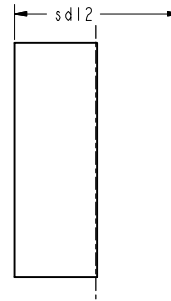

Figure 1-14 Dimensioning technique for revolved sections

MODIFYING A SKETCH

You can modify a section sketch using the various options in the **MOD SKETCH** submenu. Choose **Modify** from the **SKETCHER** menu in the **Menu Manager**. A **MOD SKETCH** submenu appears with different options.

Figure 1-15 shows the various **MOD SKETCH** submenu options. Note that all the options of the **MOD SKETCH** submenu are not available in the submenu. The remaining options are available only when you regenerate the sketch once. The **Mod Entity** option in the **MOD SKETCH** submenu is explained next and the remaining options are discussed in Chapter 2.

Mod Entity Option

The **Mod Entity** option can be used to modify the items such as dimension values, spline shape, and text. The points of the spline through which it passes can be modified using this option to alter the shape of the spline. Note that to modify a spline that is drawn using the **Approx Chain**

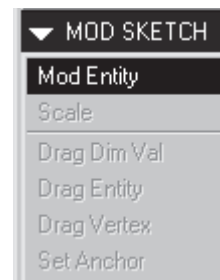

Figure 1-15 Options in MOD SKETCH submenu

option from the **TYPE** submenu in the **ADV GEOMETRY** submenu, you first need to delete the entities that were used to create splines. The **ADV GEOMETRY** submenu options are discussed in Chapter 2. Using the **Mod Entity** option you can also modify the dimension of an entity by selecting the dimension value using the left mouse button and entering a new value for the dimension.

Modifying Dimensions when the Intent Manager is On

When the **Intent Manager** is on, there are four ways to modify the dimensions of a sketch. These methods are discussed next.

Using the Modify Dimensions dialog box

You can select a dimension or more than one dimension from the sketch to modify. When you select dimension(s) from a sketch, they are highlighted in red. If you want to select more than one dimension, hold down the **SHIFT** key and select the dimensions using the left mouse button. You can also use **CTRL+ALT+A** or define a window to select all the dimensions in the sketch. Use the **Modify the values of dimensions, geometry of splines, or text entities.** button from the **Right Toolchest** to modify. The **Modify Dimensions** dialog box shown in Figure 1-16 is displayed.

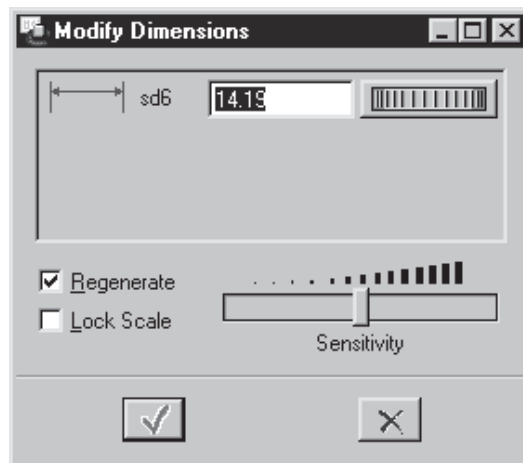

Figure 1-16 *Modify Dimensions dialog box*

To modify dimensions using this dialog box, you can either enter a value in the edit box or use the thumbwheel that is available on the right of the edit box. The **Sensitivity** slider is used to set the sensitivity of the thumbwheel.

By default the **Regenerate** check box is selected and any modifications in the dimensions are automatically updated in the sketch. If you want to delay the modification process of the sketch based on the new value of the selected dimension, you need to clear this check box. If this check box is cleared, the dimensions will not be modified until you exit this dialog box. This means that Pro/ENGINEER allows you to do multiple modifications before updating the sketch.

It is recommended to clear the **Regenerate** check box and then modify the dimensions if you have to modify more than one dimension.

The **Lock Scale** check box is used to lock the scale of a selected dimension with respect to the other selected dimensions. To lock a dimension more than one dimension should be selected.

Edit > Modify

The **Modify** option is available in the **Edit** menu in the menu bar. When you choose the **Modify** option from the **Edit** menu, a check mark appears to the left of the **Modify** option in the **Edit** menu. Now, you can select a dimension from the sketch to modify. You can modify only a single dimension using this option. When you select a dimension, the **Modify Dimensions** dialog box is displayed. By default, the **Regenerate** check box is selected. Therefore, the sketch will be regenerated dynamically as you modify the dimension.

Modifying a dimension by double-clicking on it

You can modify a dimension by double-clicking on it using the left mouse button. When you double-click on a dimension, the pop-up text field appears. Enter a new dimension value in this field and press ENTER or use the middle mouse button. Remember that you can select a dimension only when you choose **Select one item at a time - shift to gather more than one item.** button from the **Right Toolchest**.

Modifying dimensions dynamically

When the **Intent Manager** is on, Pro/ENGINEER is always in the selection mode, unless you have invoked some other tool. When you bring the cursor to an entity, the color of the entity changes to magenta. Now, if you hold down the left mouse button, a hand appears on the entity and you can modify the entity by dragging the mouse. You will notice that as the entity is modified the dimensions referenced to the selected entity will also be modified.

REGENERATING A SKETCH

You need to regenerate a sketch only when the **Intent Manager** is off. This is because when the **Intent Manager** is on, the sketch is regenerated automatically as you modify a dimension. However, if the **Intent Manager** is off, the sketch has to be regenerated manually after it is fully dimensioned and constrained so that you can proceed for the feature creation. The **Regenerate** option is available in the **SKETCHER** menu. If the sketch is underdimensioned, a message is displayed after regeneration and you are prompted to complete the dimension of the sketch. However, if the sketch is overdimensioned, the entities that are not required to be dimensioned are highlighted after regeneration. You are prompted to delete the dimensions that are not required. After the section is successfully regenerated, the **Unregenerate** option becomes active. The **Unregenerate** option is used to restore the original state of the section that was before regeneration.

DELETING OBJECTS

Choose the **Delete** option from the **SKETCHER** menu. The **DELETION** submenu appears as shown in Figure 1-17. All the options of the **DELETION** submenu are discussed next.

Delete Item Option

The **Delete Item** option is used to delete a single item at a time. The following steps explain the procedure to use the **Delete Item** option:

1. The **Delete Item** option is selected by default in the **DELETION** submenu. You are prompted to select a sketched entity, dimension, constraint, or sketcher reference to delete.
2. Select any item in the sketch to delete. The item selected disappears instantly from the graphics screen. You can continue deleting the entities by selecting them one after the other until all are deleted. After you have deleted the required number of items, select **Done** from the **SKETCHER** menu to end the deletion process.

To delete an item when the **Intent Manager** is on, select the item by defining a window using the left mouse button. The color of the selected item changes to red. Right-click on the graphics screen and hold down the right mouse button until a shortcut menu appears. Now, choose the **Delete** option from this menu. The selected item will be deleted.

Delete Many Option

The **Delete Many** option is used to delete more than one item at a time. The following steps explain the procedure to use the **Delete Many** option:

1. Select **Delete Many** from the **DELETION** submenu. You will be prompted to specify two points to indicate the diagonal of the box.
2. Specify two points such that all the items to be deleted are fully enclosed within the box. The selected items are highlighted and appear red in color. Select **Done Sel** from the **GET SELECT** menu to confirm the deletion of the selected items.
3. Continue step 2 until you delete all the items that needs to be deleted. Choose **Done** from the **SKETCHER** menu to end the deletion.

To delete more than one item from the graphics screen when the **Intent Manager** is on, select items using the SHIFT+left mouse button. You can also select the items by defining a box so that all the entities that are to be deleted are enclosed inside the box. The color of all the selected items changes to red. Right-click on the graphics screen and hold down the mouse button until a shortcut menu appears. Now, choose the **Delete** option from this menu. The selected items will be deleted.



Note

When the **Intent Manager** is on and you need to select an item from a sketch, choose the **Select one item at a time - shift to gather more than one item.** button from the **Right Toolchest** and then select the required item from the graphics screen. The term “items” used in this chapter refers to dimensions and entities.

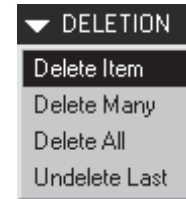

Figure 1-17 DELETION submenu

Delete All Option

The **Delete All** option is used to delete the entire sketch and dimensions in a single step. As soon as you select **Delete All** from the **DELETION** submenu the entire sketch will be deleted.

Undelete Last Option



The **Undelete Last** option is used to restore the last deleted item. This option is activated only when an item is deleted from the sketch. Select **Undelete Last** from the **DELETION** submenu. The last deleted item in the sketch will be restored. Similarly, if you have deleted more than one item in the sketch, all the items will be restored in succession from the last deleted item. This option is not available if the **Intent Manager** is on.

The **Undo Modify Dimensions** button, available when the **Intent Manager** is on, performs the same function.

GEOM TOOLS

The **GEOM TOOLS** submenu contains the basic tools that help a designer to draw the section sketches. Select **Geom Tools** from the **SKETCHER** menu. A **GEOM TOOLS** submenu appears with the options available in it. Figure 1-18 shows the different **GEOM TOOLS** submenu options and these options are discussed next.



Note

*It is evident from Figure 1-18 that all the options are not available in the **GEOM TOOLS** submenu. This is because these options are not needed in the Sketch mode.*



Figure 1-18 **GEOM TOOLS** option

Trim

When creating a design, there are a number of places where you have to remove the unwanted and extending edges. This option trims entities that extend beyond a required point of intersection. The trim option is also used to extend an entity up to the other entity. You can trim lines, circles, arcs, ellipses, etc. using this option.

Choose **Trim** from the **GEOM TOOLS** submenu. The **DRAFT TRIM** submenu is displayed with different options available as shown in Figure 1-19. The different options available in this menu are explained next.



Figure 1-19 Different options in the **DRAFT TRIM** submenu

Bound Option

The **Bound** option of the **DRAFT TRIM** submenu is used for deleting or extending a portion of an entity by defining a bounding entity. The following steps explain the procedure to use the **Bound** option to trim the entities:

1. Choose **Trim** from the **GEOM TOOLS** submenu and **Bound** from the **DRAFT TRIM**

submenu. You will be prompted to select a bounding entity to trim to. This is the bounding limit up to which the line will be deleted or extended. Figure 1-20 shows the line extended up to a bounding entity.

- Using the left mouse button, select the line that you want to be the bounding entity. When the entity is selected, its color changes to red. Now, you are prompted to select the entity to be trimmed.
- Select the line to be trimmed using the left mouse button. The line is extended up to the bounding entity. This is shown in Figure 1-20. You can change the bounding entity anytime by pressing the middle mouse button and selecting another entity as the bounding entity.

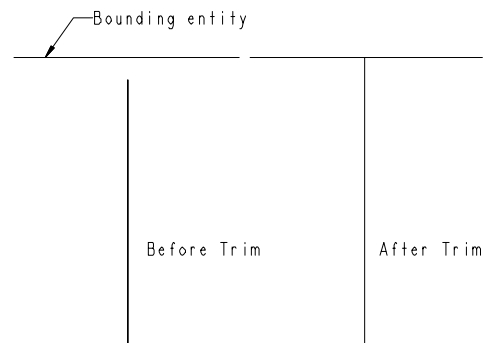

Figure 1-20 The *Bound* option

Length Option

The **Length** option is used to trim or extend an entity up to a specified length. The following steps explain the procedure to trim an entity using the **Length** option:

- Choose **Trim** from the **GEOM TOOLS** submenu and **Length** from the **DRAFT TRIM** submenu in the **Menu Manager**. The **Message Input Window** is displayed. Enter the required length you want to keep after trimming.
- After specifying the length, you will be prompted to select the entity to be trimmed. Select the entity using the left mouse button on the side you want to trim. Depending upon the original size of the entity, it will be trimmed or extended to modify the original length.

Increm Option

The **Increm** option is used to extend or shorten the entity in increments specified. To extend the entity enter a positive increment value and to shorten the entity, enter a negative increment value. The following steps explain the procedure to trim the entities using the **Increm** option:

- Choose **Trim** from the **GEOM TOOLS** submenu and **Increm** from the **DRAFT TRIM** submenu. The **Message Input Window** is displayed. Enter the incremental length.
- After specifying the incremental length, you will be prompted to select the entity to be trimmed. Select the side of the entity where you want to extend using the left mouse button. Continue selecting the entity as much as you want to extend it. The line will be extended according to the incremental length. Use the middle mouse button to quit the trimming operation.

Corner Option

The **Corner** option is used to trim two entities at their corners. Note that when you trim entities using this option, the portion from where you select the entities is retained and the

other portion is trimmed.



When the **Intent Manager** is on, you can use the **Trim entities (cut or extend) to other entities or geometry.** button to trim. The following steps explain the procedure to trim entities using the **Corner** option:

1. Choose **Trim** from the **GEOM TOOLS** submenu and **Corner** from the **DRAFT TRIM** submenu. You will be prompted to select two entities to be trimmed.
2. Using the left mouse button, select the two entities on the sides you want to keep after trimming, see Figure 1-21. These two entities must be intersecting entities. The entities are trimmed from the point of intersection.

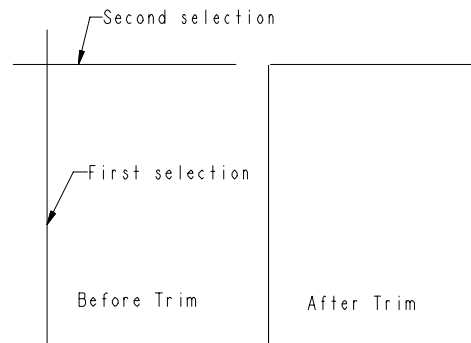

Figure 1-21 Trimming the lines using the **Corner** option

Untrim Last Option

The **Untrim Last** option is available only after any trimming operation is performed. This option is used to untrim the last entity trimmed. As soon as you select the **Untrim Last** option from the **DRAFT TRIM** submenu the last entity trimmed is automatically restored.

Mirror

The **Mirror** option is used to mirror sketched geometries about a centerline. This option helps reduce the time consumed for creation of symmetrical geometries and the process of dimensioning the symmetrical entities.



When the **Intent Manager** is on, you can use the **Mirror selected entities.** button to mirror.

The following steps explain the procedure to mirror a sketched geometry when the **Intent Manager** is off:

1. Sketch a geometry using the sketcher options. Sketch a center line about which you have to mirror the geometry.
2. Choose **Mirror** from the **GEOM TOOLS** submenu. You will be prompted to select the center line about which you have to mirror. Select the center line using the left mouse button. The color of the center line changes to red.
3. You will be prompted to select the entities you want to mirror. The **MIRROR** menu is displayed that can be used to select individual entities or all the entities for mirroring. If you select individual entities, the color of all the entities selected to mirror changes to red. However, if you select all the entities using the **All** option, they will be mirrored automatically.

4. Choose **Done Sel** from the **GET SELECT** submenu. The entities selected are mirrored about the center line.

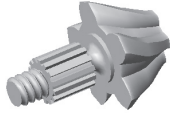

Tip: In case of symmetrical parts, you can save the time involved in dimensioning the sketch by dimensioning half of the section and then mirroring it. Pro/ENGINEER will assume that the mirrored half has the same dimensions as the sketched half.

GET SELECT SUBMENU

The options of the **GET SELECT** submenu are used as the basic tool to select the entities on the graphics screen. The different options available in the **GET SELECT** submenu are shown in Figure 1-22. These options are discussed next.



Figure 1-22 GET SELECT submenu

Pick

The **Pick** option is used to select any geometric as well as dimensional entity. The picking action is performed by using the left mouse button on the entity you have to select.

Query Sel

The **Query Sel** option makes the selection process easier and provides an opportunity to rectify the selection any number of times before confirming it. Whenever you have to select an entity for modification or other purposes select the **Query Sel** option and then make the selection. The **Query Bin** appears with the name of the entity or entities that are selected. If your selection is wrong, you can change your selection any number of times before confirming it. To confirm the selection, choose the **Accept** button in the **Query Bin**.



Figure 1-23 Query Bin

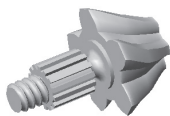

Tip: You can also use the right mouse button to invoke the **Query Sel** option. After viewing your selection in the **Query Bin** window press the middle mouse button to accept the selection.

Sel By Menu

This option is used mostly in the part mode when you have to select the datum planes and so on. It will be discussed in later chapters.

Done Sel

This option when selected confirms the selections you made. This is equivalent to pressing the middle mouse button. Select **Done Sel** to end your selections.

Quit Sel

This option is used to quit any selections you have made.

DRAWING DISPLAY OPTIONS

While working with complex sketches, you need to increase the display of a particular portion of a sketch so that you can work on minute details of the sketch. For example, if you are drawing a sketch of a piston, you have to work on the minute details of the grooves for the piston rings. To work on these minute details, you have to enlarge the display of these grooves. You can enlarge or reduce the drawing display using the various drawing display options provided in Pro/ENGINEER. Some of these drawing display options are discussed next. The remaining drawing display options will be discussed in later chapters.

Zoom In



This option enlarges the view of the drawing on the screen. When you choose the **Zoom In** button, you will be prompted to define a box. The area that you will enclose inside the box will be enlarged and displayed on the graphics screen. Note that when you enlarge the view of the drawing, the original size of the entities is not changed.

Zoom Out



This option reduces the view of the drawing on the screen, thus increasing the drawing display area.

Refit object to fully display it on the screen



This option reduces or enlarges the display such that the entities that comprise the sketch are fitted inside the current display. Note that the dimensions may not necessarily be included in the current display.

Redraw the current view



While working with complex sketches, some unwanted temporary information is retained on the screen. The unwanted information include the shadows of the deleted sketched entities, dimensions, and so on. This unwanted information can be removed from the graphics screen using the **Redraw the current view** option. This option will be extensively used while designing in Pro/ENGINEER.

TUTORIALS

Tutorial 1

In this tutorial, you will draw the sketch shown in Figure 1-24 using the basic sketcher options. You will draw the sketch both without using the **Intent Manager** and using the **Intent Manager**.
(Expected time: 30 min)

Sketch Without Using the Intent Manager

The following steps outline the procedure for creating this sketch without using the **Intent Manager**:

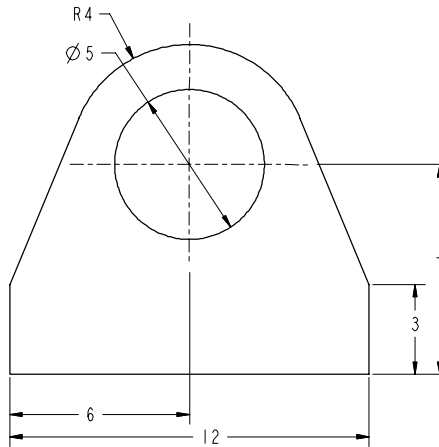

Figure 1-24 Sketch for Tutorial 1

- Start Pro/ENGINEER.
- Set the working directory and create a new object file.
- Turn off the **Intent Manager**. Draw lines using the sketcher options.
- Draw an arc and a circle.
- Dimension the sketch and then modify the dimensions of the sketch.
- Regenerate the sketch and then save it.

Starting Pro/ENGINEER

- Start Pro/ENGINEER by double-clicking on the Pro/ENGINEER icon on the desktop of your computer or by using the **Start** menu.

Setting the Working Directory

When Pro/ENGINEER session is started, the first task is to set the working directory. A working directory is a directory on your system where you can save the work done in the current session of Pro/ENGINEER. You can set any directory existing on your system as the working directory. Since this is the first tutorial of this chapter, you need to create a folder named **c01**, if it does not exist.

- Choose the **Set Working Directory** option from the **File** menu. The **Select Working Directory** dialog box is displayed as shown in Figure 1-25.
- Browse and select **C:\ProE**. It is assumed that the **ProE** folder exists.

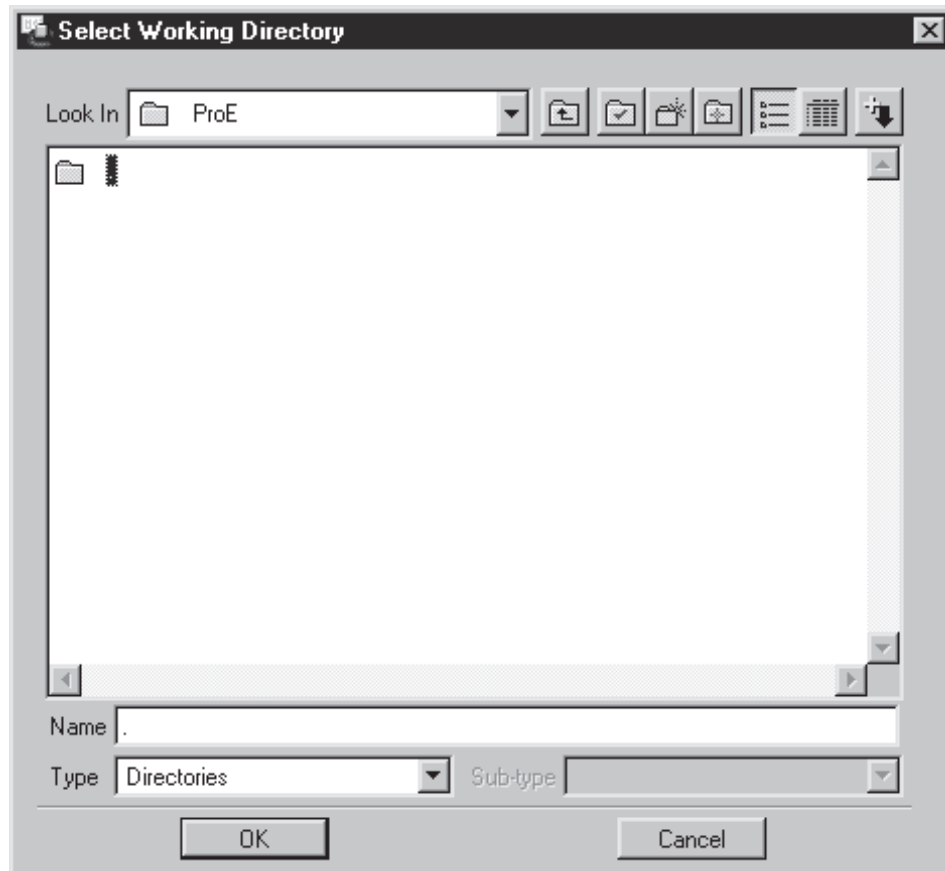



Figure 1-25 Select Working Directory dialog box

3. Choose the **New Directory** button in the **Select Working Directory** dialog box. The **New Directory** dialog box is displayed. 
4. Type **c01** in the **New Directory** edit box. Choose **OK** from the dialog box. You have created a folder named c01 in **C:\ProE**.
5. Choose **OK** from the **Select Working Directory** dialog box. You have set the working directory to **C:\ProE\c01**. A message is displayed in the **Message Area** that the directory successfully changed to C:\ProE\c01 directory.

Creating New Object File

Any sketch drawn in the Sketch mode is saved with file extension .sec. This file format is one of the file formats available in Pro/ENGINEER.

1. Choose the **Create a new object** button from the **File** toolbar to display the **New** dialog box. Select the **Sketch** radio button from the **Type** area of the **New** dialog box. A default name of the sketch appears in the **Name** edit box. 

2. Enter **c01tut1-1** in the **Name** edit box, see Figure 1-26. Choose the **OK** button.

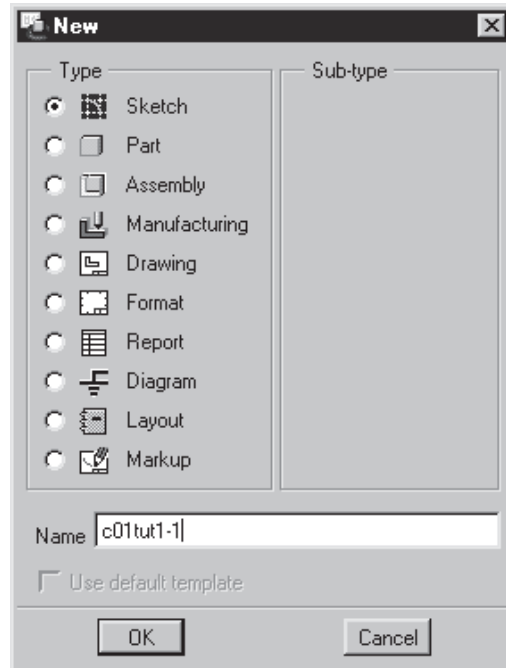

Figure 1-26 New dialog box

You will enter the sketcher environment of the Sketch mode. When you enter the sketcher environment, the **Intent Manager** is on by default. This is evident from the buttons available on the **Right Toolchest**. You can also reconfirm this from the check mark that is displayed on the left of the **Intent Manager** option in the **Sketch** menu in the menu bar.

3. To exit the **Intent Manager**, choose the **Intent Manager** option to clear the check mark. The **Right Toolchest** is no more displayed and the **Menu Manager** is displayed on the right of the window. The **Menu Manager** contains all the sketcher options.

Drawing the Lines in the Sketch

You will start drawing the given sketch from the right side of the sketch.

1. From the **GEOMETRY** submenu in the **Menu Manager**, choose the **Line** option. The **LINE TYPE** submenu is displayed.

You will notice that the **Geometry** and the **2 Points** options are selected by default in the **LINE TYPE** submenu.

2. Choose the **Vertical** option from the **LINE TYPE** submenu. You will be prompted to select a start point.
3. Using the left mouse button, specify the start point on the right of the graphics screen.

You will notice that a red line is being drawn.

4. Move the cursor down to get an approximate size of the line and using the left mouse button specify the end point of the vertical line. This is the right vertical line shown in Figure 1-27.

You will notice that another rubber-band line is being drawn. The start point of this line is the endpoint of the last line. This line will change its size as you move the cursor. This is because the endpoint of this line is not defined. Also, note that in the **LINE TYPE** submenu, the **Horizontal** option is highlighted. This means that a horizontal line will be drawn.

5. Move the cursor toward left on the graphics screen. A horizontal rubber-band line is drawn. Approximately size the line and when you get the desired size, use the left mouse button to specify the end point of the horizontal line. The horizontal line is shown in Figure 1-27.

You will notice that a new vertical rubber-band line is being drawn. The start point of this line is the end point of the last line. Also, note that in the **LINE TYPE** submenu, the **Vertical** option is highlighted. This means, that a vertical line will be drawn.

6. Move the cursor upwards on the graphics screen. A vertical red rubber-band line is drawn. Size the line approximately and after getting the desired size, use the left mouse button to specify the end point of the left vertical line as shown in Figure 1-27.

7. Press the middle mouse button to end line creation.



The sketch after drawing the lines is shown in Figure 1-27.

Figure 1-27 First vertical line, second horizontal line, and third vertical line

8. From the **LINE TYPE** submenu in the **Menu Manager**, choose the **2 Points** option. You will be prompted to select a start point.
9. Use the left mouse button to start an inclined line from the endpoint of the last vertical line. Size the line and specify the end point of the line. The inclined line is shown in Figure 1-28. Press the middle mouse button to end line creation. The **2 Points** option is still active.

Remember that to start the line from the endpoint of the previous line, the start point of the line need not be exactly on the endpoint of the previous line. This is because when you dimension these entities in the sketch, the dimensions will automatically close the sketch if the points are close to each other. You can also use the **Trim > Corner** option

discussed earlier in the chapter to clean the corners.

- Use the left mouse button to start an inclined line from the start point of the first vertical line. Size the line approximately and specify the endpoint of the line. Press the middle mouse button to end line creation. The two inclined lines are shown in Figure 1-28.

The lines in the sketch are drawn and now you need to draw an arc and a circle. If the space on the graphics screen is not enough to draw the arc, you can modify the current display using the CTRL+left mouse button or CTRL+right mouse button.

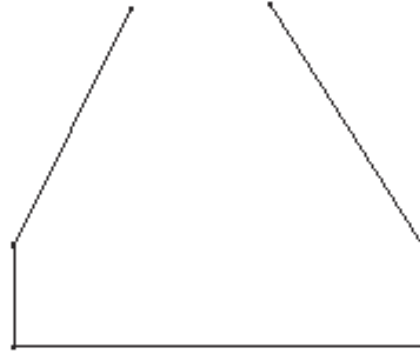

Figure 1-28 Left and right inclined lines

Drawing the Arc

- From the **GEOMETRY** menu in the **Menu Manager**, choose **Arc > Tangent End**. You will be prompted to select the end of an entity to determine tangency.
- Using the left mouse button, select the end point of the left inclined line. The red rubber-band arc appears.
- Using the left mouse button, select the endpoint of the right inclined line as the endpoint of the arc, see Figure 1-29.

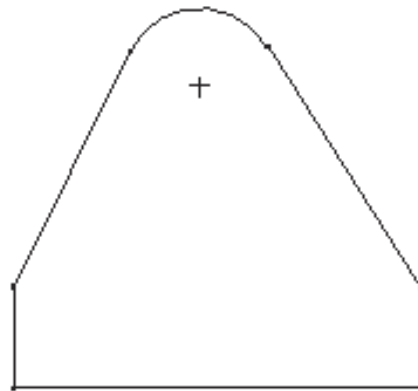

Figure 1-29 Arc drawn tangent to the lines

Drawing the Circle

The circle in the sketch is concentric to the arc. This means that the centers of the arc and the circle lies at the same point. Therefore, you need to use the **Concentric** option to draw circle.

- From the **GEOMETRY** submenu in the **Menu Manager**, choose the **Circle** option. The **CIRCLE TYPE** submenu is displayed.
- Choose **Geometry > Concentric** from this menu. You will be prompted to select an arc.
- Using the left mouse button, select the arc that you created earlier. Now, you are prompted to use the left mouse button and drag the mouse.
- Use the left mouse button to select a point inside the sketch. A red rubber-band circle appears.

5. Size this circle approximately by moving the mouse and complete it by using the left mouse button. The circle drawn is shown in Figure 1-30.

The sketch is completed and now you will dimension it.

Linear Dimensioning

All the dimensions that are shown in Figure 1-31 are required to regenerate the sketch. In the figure you will notice that all the entities of the sketch are not dimensioned. This is because dimensioning all the entities is not needed. Pro/ENGINEER highlights the dimensions that are not needed in the sketch in red color after you regenerate the sketch.

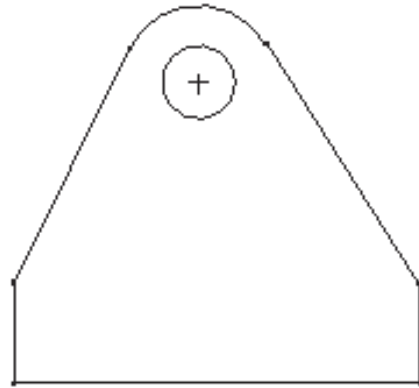

Figure 1-30 Sketch after drawing all the entities

1. In the **Menu Manager**, choose the **Dimension** option from the **SKETCHER** menu. The **DIMENSION** submenu is displayed.

The **Normal** option in this submenu is chosen by default.

2. Using the left mouse button, select the right vertical line from the sketch. The selected line is highlighted red in color.
3. Now, place the dimension using the middle mouse button on the right of the sketch, see Figure 1-31. The dimension appears as **sd0**. This is the first dimension of the sketch, therefore it is named as **sd0**.
4. Using the left mouse button select the bottom horizontal line and place the dimension below the sketch using the middle mouse button, see Figure 1-31. This dimension appears as **sd1**.
5. Using the left mouse button, select the center point of the circle and then select the bottom horizontal line. Both the center point and the line turn red in color.
6. Using the middle mouse button, place the dimension on the right of the **sd0** dimension, see Figure 1-31. This dimension appears as **sd2**.
7. Using the left mouse button, select the center point of the circle and then select the left vertical line. Both the center point and the vertical line turn red in color.
8. Using the middle mouse button, place the dimension above the **sd1** dimension, see Figure 1-31. This dimension appears as **sd3**.

Radial Dimensioning the Arc

The **Dimension > Normal** option is still active and will remain active until you choose some other option from the **Menu Manager**.

1. Select the arc from the graphics screen using the left mouse button. The selected arc turns red in color.
2. Using the middle mouse button, place the dimension above the sketch, see Figure 1-31.

The arc is radially dimensioned and the dimension is displayed as **sd4** in the sketch. The naming of dimension is done by default. The first dimension you created in the sketch is sd0, the second dimension is sd1, and so on. But, if you delete a dimension that is already created and then again dimension it, the dimension number will be incremented by one.

The dimensioning of various entities in the sketch is shown in Figure 1-31.

Diameter Dimensioning the Circle

To dimension a circle, if you select it once then the circle is dimensioned radially. However, if you select it twice then it is dimensioned diametrically.

1. Using the left mouse button select the circle on the graphics screen twice. The selected circle turns red in color.
2. Using the middle mouse button, place the dimension on the right of the sketch below the sd4 dimension, see Figure 1-31.

The diameter dimension of the circle is created and will be displayed as **sd5** in the sketch.

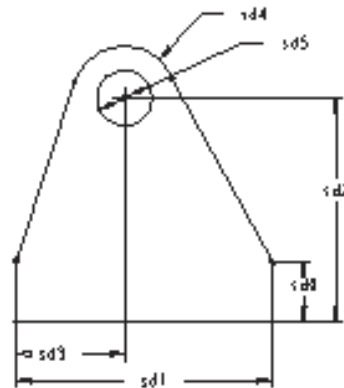

Modifying the Dimensions

Next, you need to modify all the dimensions that you applied to the sketch. This is because Pro/ENGINEER assigns some default values to the entities that were dimensioned. These default dimensions are displayed in the **Message Input Window** that is displayed when you select a dimension to modify. Remember that to select a dimension to modify, the text should be selected using the left mouse button. For example, the cursor should point on sd0 to modify the sd0 dimension.

1. Choose the **Modify** option from the **SKETCHER** menu in the **Menu Manager**. The **MOD SKETCH** submenu is displayed and the **Mod Entity** option is chosen by default.
2. Select the text of first dimension that by default is named as **sd0**. The selected dimension turns red in color and the **Message Input Window** is displayed with a default value.
3. Enter a value of **3** in the **Message Input Window** and press ENTER or choose the check

mark on the **Message Input Window**. The modified dimension turns white in color and the dimension value is displayed in place of sd0.

4. Select the text of second dimension of the bottom horizontal line that by default is named as **sd1**. The selected dimension turns red in color and the **Message Input Window** is displayed with a default value.
5. Enter a value of **12** in this window and press ENTER. The modified dimension turns white in color on the graphics screen.
6. Select the text **sd2**. The selected dimension turns red in color and the **Message Input Window** is displayed with a default value.
7. Enter a value of **7** in this window and press ENTER. The modified dimension turns white in color on the graphics screen.
8. Select the text **sd3**. The selected dimension turns red in color and the **Message Input Window** is displayed with a default value.
9. Enter a value of **6** in this window and press ENTER.
10. Select the text of radial dimension that is by default named as **sd4**. The selected dimension turns red in color and the **Message Input Window** is displayed with a default value.
11. Enter a value of **4** in this window and press ENTER.
12. Select diameter dimension that is by default named as **sd5**. The selected dimension turns red in color and the **Message Input Window** is displayed with a default value.
13. Enter a value of **5** in this window and press ENTER. All the dimensions of the sketch are modified and now the sketch needs to be regenerated.

Regenerating the Sketch

The sketch in sketcher environment is drawn with some default size. Then you apply the dimensions and modify them according to the specifications. To resize the sketch according to the given dimensions you have to regenerate the sketch. If the sketch drawn is complete and fully dimensioned and you choose the **Regenerate** option from the **SKETCHER** menu, the **Section regenerated successfully**. message is displayed in the **Message Area**.

1. Choose the **Regenerate** option from the **SKETCHER** menu in the **Menu Manager**. The sketch is regenerated successfully and the sketch is now complete, see Figure 1-32.

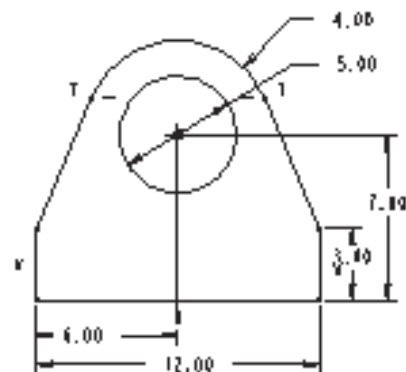



Figure 1-32 Sketch after regeneration

**Note**

If the sketch is not regenerated and you are prompted to add dimensions, dimension the entity that is highlighted red.

Saving the Sketch

You have to save the sketch because you may need the sketch later.

1. Choose the **Save the active object** button from the **File** toolbar. The **Message Input Window** is displayed with C01TUT1-1.SEC, the name of the sketch. This is the name that you had entered earlier. 
2. Press ENTER or choose the check mark on the **Message Input Window**. The sketch is saved.
3. Choose **SKETCHER > Done** from the **Menu Manager** to exit the sketcher environment.

Sketch Using the Intent Manager

The following steps outline the procedure for creating this sketch using the **Intent Manager**.

- a. Create a new object file.
- b. Draw lines using the tool button for creating lines.
- c. Draw an arc and a circle using respective tool buttons.
- d. Dimension the sketch and then modify the dimensions of the sketch.
- e. Save the sketch.

Creating New Object File

1. Choose the **Create a new object** button from the **File** toolbar. The **New** dialog box is displayed. Select the **Sketch** radio button from the **Type** area of the **New** dialog box. A default name of the sketch appears in the **Name** edit box.
2. Enter **c01tut1-2** in the **Name** edit box. Choose the **OK** button.

You will enter the sketcher environment of the Sketch mode. When you enter the sketcher environment, the **Intent Manager** is on by default.

Drawing the Lines of the Sketch

You will start drawing the sketch with the right vertical line.

1. Choose the **Create lines.** button from the **Right Toolchest**. 
2. Using the left mouse button, specify the start point on right on the graphics screen. One end of the line is attached to the cursor. Move the cursor down to get an approximate size

of the line.

You will notice that when the cursor is moved vertically downwards a red colored constraint named **V** appears on the graphics screen next to the line. This shows that if you draw a line now then the vertical constraint will be applied to the line.

3. Use the left mouse button to specify the end point of the line. The vertical constraint **V** is applied to the line and the symbol **V** appears in yellow. The color of the constraint indicates that this constraint is strong. This means that you cannot change the orientation of this line until you delete the constraint that is applied on the line.

Another rubber-band line is attached to the cursor with the start point as the endpoint of the last line.

4. Move the cursor horizontally toward left, a horizontal rubber-band line extends to the left as you move the mouse.
5. After you get the desired size of the line, use the left mouse button to end the line. You will notice that a horizontal constraint named **H** that is yellow in color is applied to the line.
6. Move the cursor upwards on the graphics screen. A vertical rubber-band line extends as you move the mouse. As you move the cursor upwards, you will notice that at a particular point where the length of the left vertical line is equal to the length of the right vertical line, **L₁** symbol is displayed on both the vertical lines. This symbol suggests that equal length constraint is applied to the two vertical lines.
7. When **L₁** constraint appears on the vertical line, use the left mouse button to specify the end point of the vertical line. You will notice that **L₁** constraint is displayed in gray color as shown in Figure 1-33. This suggests that it is a weak constraint. The rubber-band line is still attached to the cursor.

You can also apply the constraints later but to save an extra step of adding the constraints, you will use the constraints that are applied automatically while drawing.

8. Move the cursor to size the line and specify the endpoint of the left inclined line, see Figure 1-33.
9. Press the middle mouse button to end line creation. You will notice that gray colored dimensions are applied to the sketch, see Figure 1-33. The color of these dimensions indicate that these dimensions are weak dimensions. These dimensions are automatically deleted anytime while you are completing the sketch or when you are adding dimensions and constraints manually. When deleting the weak dimensions, the system does not confirm their deletion.
10. The line option is still active. Move the cursor close to the top end of the right vertical line. You will notice that as you bring the cursor close to the top end, the cursor snaps to that point. Select the point using the left mouse button.

11. Size the inclined line and specify the endpoint of the right inclined line. Press the middle mouse button to end line creation.

Figure 1-34 shows all the lines that you have drawn. Now, the arc and circle is will be drawn.

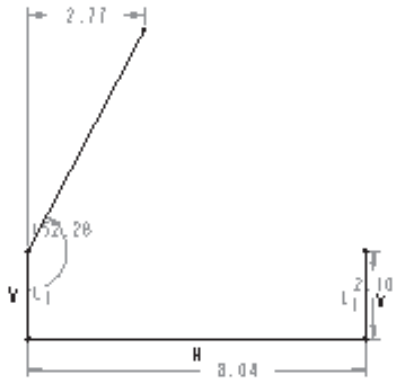

Figure 1-33 Lines with weak dimensions

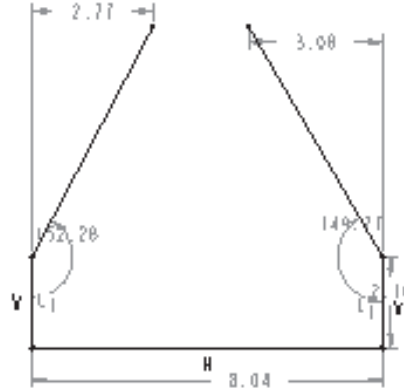



Figure 1-34 Partial sketch with weak dimensions

Drawing the Arc

1. Choose the **Create an arc by 3 points or tangent to an entity at its endpoint.** button from the **Right Toolchest**. You will be prompted to select the start point of the arc. 
2. Using the left mouse button, one by one select the top endpoints of the two inclined lines. A rubber-band arc appears. Move the cursor upwards. As you move the cursor; at a particular point the tangent constraint is applied at both the ends of the arc. This is evident by a symbol **T** that appears on the endpoint of the inclined line.
3. As the tangent constraint appears, use the left mouse button to end arc creation. You will notice that the tangent constraint with a symbol **T** appears at the end points of the arc as evident from Figure 1-35. Press the middle mouse button to end arc creation.

The tangent constraint **T** will appear in yellow, which suggests that it is a strong constraint and the tangency of the inclined line with the arc cannot be modified until you delete the tangent constraint.

Note that in Figure 1-34 there are some weak dimensions that are not displayed in Figure 1-35. This is because the weak dimensions are deleted without confirming their deletion. Hence, after drawing the arc some weak dimensions got deleted automatically.

Drawing the Circle

1. Choose the black arrow on the right of the **Create circle by picking the center and a point on the circle.** button to display the flyout. From this flyout, choose the **Create concentric circle.** button. You will be prompted to select an arc. 

2. Select the arc using the left mouse button. Move the mouse and a circle appears.
3. Using the left mouse button select a point inside the sketch to define the circle.
4. Press the middle mouse button to end circle creation. The sketch is complete and appears similar to that shown in Figure 1-36.

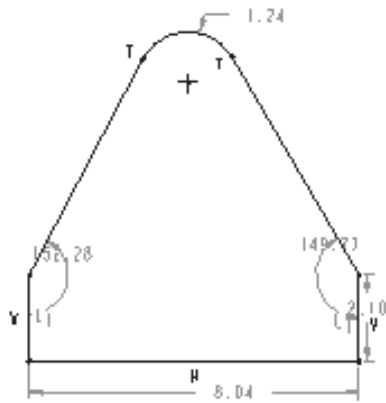

Figure 1-35 Sketch with arc

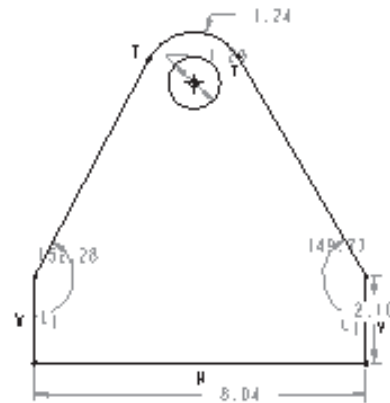

Figure 1-36 Sketch with all the entities, weak dimensions, and weak constraints



Note

If the tangent constraint symbol is not displayed on any of the inclined lines, apply the constraint manually using the **Constraints** dialog box that is displayed when you choose the **Impose sketcher constraints on the section.** button from the **Right Toolchest**.

Dimensioning the Sketch

The right vertical line, the bottom horizontal line, the arc, and the circle are dimensioned automatically and weak dimensions are applied to them. You will use these dimensions. Hence, there is no need to dimension these entities again.

1. Choose the **Create defining dimension.** button. 
2. Using the left mouse button, select the center point of the circle and then select the bottom horizontal line. Both, the center point and the line turn red in color.
3. Using the middle mouse button, place the dimension on the right of the sketch.
4. Using the left mouse button, select the center of the circle and then select the left vertical line. Both, the center and the vertical line turn red in color.
5. Using the middle mouse button, place the dimension below the sketch as shown in Figure 1-37. Remember that when you add dimensions while the **Intent Manager** is on, the dimension values are displayed instead of dimension symbols.

Modifying the Dimensions

The sketch is dimensioned with default values. You need to modify these values to the given values.

1. Choose the **Select one item at a time - shift to gather more than one item.** button. 
2. Select all the dimensions using the SHIFT+left mouse button.



Note

You can also use CTRL+ALT+A to select the whole sketch with dimensions.

3. When all the dimensions turn red in color, choose the **Modify the values of dimensions, geometry of splines, or text entities.** button. The **Modify Dimensions** dialog box is displayed. 

All the dimensions in the sketch are displayed in this dialog box and each dimension has a separate thumbwheel and an edit box. You can use the thumbwheel or the edit box to modify the dimensions. It is recommended to use the edit boxes to modify the dimensions if the change in dimension value is large.

4. Clear the **Regenerate** check box and then modify the values of the dimensions. When you clear this check box, then any modification in a dimension value does not update the sketch. It is recommended to clear the **Regenerate** check box when more than one dimension has to be modified.

You will notice that the dimension you select in the **Modify Dimensions** dialog box is enclosed in a yellow box on the graphics screen.

5. After modifying all the dimensions, choose the  **Regenerate the section and close the dialog** button from the **Modify Dimensions** dialog box. A message **Dimension modifications successfully completed.** is displayed in the **Message Area**.

The sketch is complete and is shown in Figure 1-37. When you are sketching with **Intent Manager** on, the sketch is automatically regenerated after the dimensions are modified.

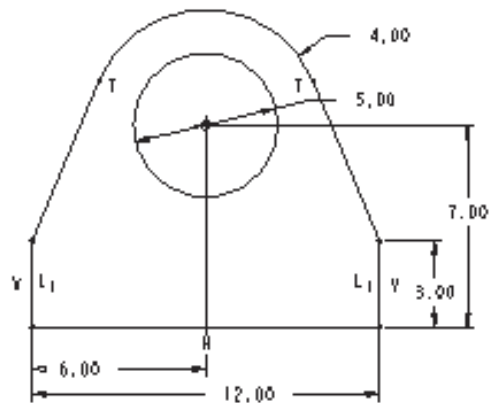



Figure 1-37 Sketch with dimensions and constraints for Tutorial 1

Saving the Sketch

The sketch will now be saved. You have to save the sketch because you may need the sketch later.

1. Choose the **Save the active object** button from the **File** toolbar. The **Message Input Window** is displayed with the name of the sketch that you had entered earlier. 
2. Press ENTER. The sketch is saved.
3. After saving the sketch, choose the **Continue with the current section.** button to exit the sketch. 

Tutorial 2

In this tutorial you will draw the sketch shown in Figure 1-38. Draw the sketch both without using the **Intent Manager** and using the **Intent Manager**. For your reference, all the entities in the sketch are assigned alphabetical labels. **(Expected time: 30 min)**

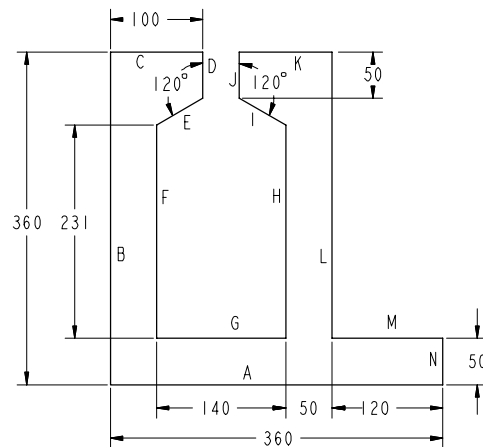

Figure 1-38 Sketch for Tutorial 2 with dimensions and labels for identification

Sketch Without Using the Intent Manager

The following steps outline the procedure for creating this sketch without using the **Intent Manager**:

- a. Set the working directory and create a new object file.
- b. Turn off the **Intent Manager**. Draw the sketch using the sketcher options.
- c. Dimension the sketch and then modify the dimensions of the sketch.
- d. Regenerate the sketch.

Setting the Working Directory

The working directory was selected in Tutorial 1, therefore there is no need to select the working directory again. But if you still want to select the working directory, choose the **Set Working Directory** option from the **File** menu. The **Select Working Directory** dialog box is displayed. Set the working directory to **C:\ProE\c01**.

Creating New Object File

1. Choose **Create a new object** button from the **File** toolbar. The **New** dialog box is displayed. Select the **Sketch** radio button from the **Type** area of the **New** dialog box. A default name of the sketch appears in the **Name** edit box.
2. Enter **c01tut2-1** in the **Name** edit box. Choose the **OK** button.
3. You will enter the sketcher environment of the Sketch mode.



When you enter the sketcher environment the **Intent Manager** is on. To exit the **Intent Manager**, choose the **Intent Manager** option in the **Sketch** menu. The **Sketch** menu is available on the menu bar.

Drawing the Sketch

The sketch consists of lines only. For easy explanation, all the lines in the sketch are named.

1. From the **GEOMETRY** submenu in the **Menu Manager**, choose the **Line** option. The **LINE TYPE** submenu is displayed. The **Geometry** and the **2 Points** option is selected by default.
2. Choose the **Horizontal** option from the **LINE TYPE** submenu. You will be prompted to select a start point.

Start from right on the graphics screen and start drawing line A as discussed in next step.
3. Using the left mouse button specify the start point of line A on the right side of the graphics screen. Move the cursor to the left on the graphics screen and size the line.
4. Using the left mouse button, specify the endpoint of the line as shown in Figure 1-39. You will notice that when you move the mouse, the red line extends in the vertical direction only.
5. Move the cursor upwards to size line B and using the left mouse button specify the end point of line B as shown in Figure 1-39. Now, when you move the mouse, you will notice that a red line extends in the horizontal direction only.
6. Move the cursor to the right on the graphics screen and using the left mouse button specify the endpoint of line C, see Figure 1-39.
7. Now, you will draw line D. Move the cursor down and using the left mouse button specify

the endpoint of line D as shown in Figure 1-39.

Now, you need to end line creation because the next line to be drawn is inclined at an angle.

8. Press the middle mouse button to end line creation.
9. Choose the **2 Points** option from the **LINE TYPE** submenu. You will be prompted to select a start point.
10. Using the left mouse button, select the endpoint of line D as the start point for line E. Move the mouse to size the line.
11. Using the left mouse button, specify the endpoint of line E, see Figure 1-39.

Now, you have to abort the **2 Points** option because the next line to be drawn is vertical. Press the middle mouse button to abort line creation.

12. Choose the **Vertical** option from the **LINE TYPE** submenu to draw the vertical line F. You will be prompted to select a start point.
13. Using the left mouse button, select the endpoint of line E as the start point for line F. Move the mouse to size the line and use the left mouse button to specify the endpoint of the line. Line F is completed as shown in Figure 1-39.

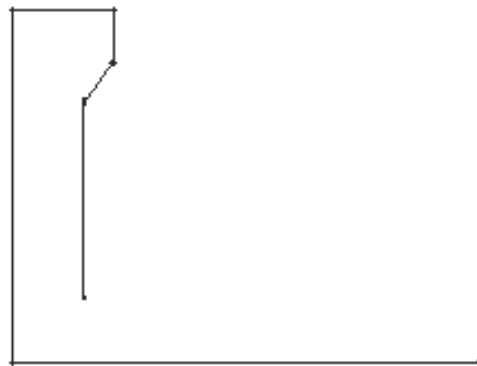

Figure 1-39 Sketch after drawing lines A to F

14. Now, draw line G. Using the left mouse button specify the endpoint of line G. Line G is completed, see Figure 1-40.
15. Move the cursor upwards and using the left mouse button specify the endpoint of line H.
16. Now, press the middle mouse button to end line creation. You need to end line creation because the next line to be drawn is inclined at an angle.
17. Choose the **2 Points** option from the **LINE TYPE** submenu. You will be prompted to specify the start point of the line.
18. Select the endpoint of line H as the start point for line I. Move the cursor to size the line.
19. Using the left mouse button, specify the endpoint of line I, see Figure 1-40. A red line is attached to the cursor. Press the middle mouse button to end line creation. You need to do

this because the next line to be drawn is vertical.

20. Choose the **Vertical** option to draw line J. Using the left mouse button, specify the endpoint of line I as the start point for line J.
21. Move the cursor to size the line and using the left mouse button, specify the endpoint of the line. Line J is completed as shown in Figure 1-40.
22. Move the cursor to the right of the sketch and using the left mouse button specify the endpoint of line K as shown in Figure 1-40.
23. Move the cursor downwards. Using the left mouse button, specify the endpoint of line L, see Figure 1-40.
24. Move the cursor to the right of the sketch and using the left mouse button, specify the endpoint of line M as shown in Figure 1-40.
25. Move the cursor downwards to draw line N. Using the left mouse button, specify the endpoint of line N at the point you started from. Press the middle mouse button to end line creation.

The sketch is completed and is shown in Figure 1-40. But, you will notice that the endpoints of the lines are not joined. If you are not able to notice it then use the **Zoom In** button from the **View** toolbar to zoom a particular area on the graphics screen. As mentioned in the previous tutorial, the sketch will be closed when you add the dimension. You can also trim the corners of the sketch to close the corners of the sketch.

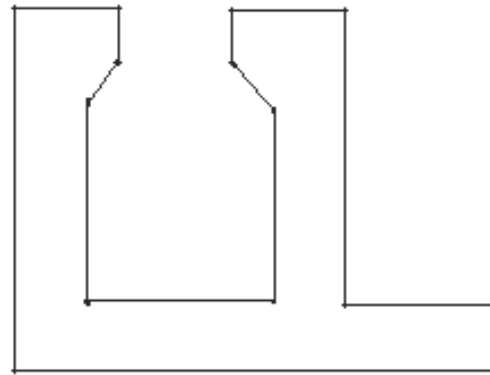

Figure 1-40 Sketch after drawing all the lines

Trimming the Corners

To join all the corners in the sketch, you need to trim the corners formed by lines. A sketch can have an open section in the Sketch mode but in this sketch you need a closed section.

1. Choose the **Geom Tools** option from the **SKETCHER** menu in the **Menu Manager**. The **GEOM TOOLS** submenu is displayed.
2. From the **GEOM TOOLS** submenu, choose the **Trim** option. The **DRAFT TRIM** submenu is displayed. The **Corner** option is selected by default in this submenu and you are prompted to select the two entities to be trimmed.
3. Using the left mouse button, select any two lines that form a corner. The two lines are joined and the corner is now closed.

- Trim all the corners in the sketch so that the sketch becomes a single closed loop.



Note

It is not necessary to trim the corners in the sketch to make the sketch a closed loop. When you dimension the sketch and then modify the dimension values, the sketch is closed automatically. However, it is recommended to close the sketch by trimming the corners of the sketch.

*When you are not using the **Intent Manager** to draw a sketch, constraints are applied to the sketch automatically but you can view these constraints only when you choose **SKETCHER > Constraints** or when the sketch is regenerated. You cannot apply constraints manually; therefore you may need to dimension some entities that have equal dimensions. For example, lines H and F in Figure 1-36 have equal dimensions but you may need to dimension both of them.*

Dimensioning the Sketch

- Choose the **Dimension** option from the **SKETCHER** menu in the **Menu Manager**. The **DIMENSION** submenu is displayed. The **Normal** option is selected by default.
- Select line A using the left mouse button. The line turns red in color. Now, using the middle mouse button, place the dimension below the sketch. The dimension appears as **sd0**, see Figure 1-41.
- Select line B using the left mouse button. Using the middle mouse button, place the dimension on the left of the sketch. The dimension appears as **sd1**, see Figure 1-41.
- Select line C. Using the middle mouse button, place the dimension at the top of the sketch. The dimension appears as **sd2**.
- Select lines D and E using the left mouse button. The selected lines turn red in color. Now, using the middle mouse button place the dimension close to the vertex where lines D and E join. The dimension appears as **sd3**.
- Select line F. Using the middle mouse button, place the dimension on the left of the sketch but inside the **sd1** dimension. The dimension appears as **sd4**.

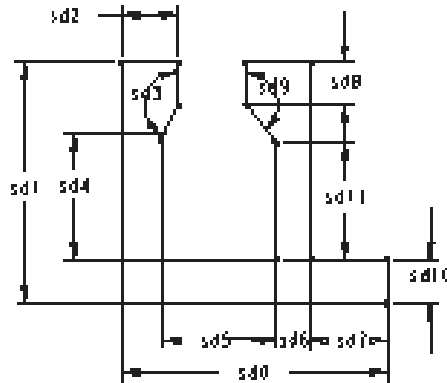

Figure 1-41 Sketch after applying dimensions

Similarly, dimension all the entities that are shown in the sketch in Figure 1-41.

Modifying the Dimensions

- Choose the **Modify** option from the **SKETCHER** menu. The **MOD SKETCH** submenu is displayed. As mentioned earlier, you need to select the text of dimensions to modify them.

2. Select the dimension named sd0 using the left mouse button. The **Message Input Window** is displayed. Enter the required dimension value in this window. Press ENTER. The selected dimension is modified on the screen.

Similarly, modify all the dimension values as shown in Figure 1-42.

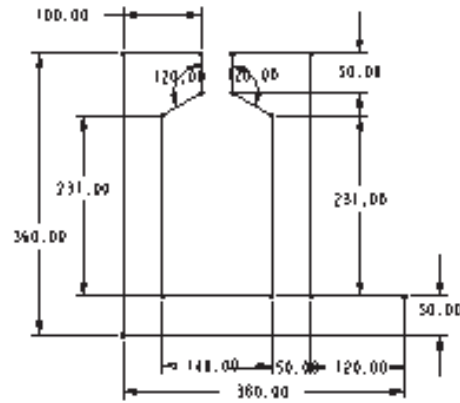

Figure 1-42 Sketch after modifying dimensions

Regenerating the Sketch

1. Choose **Regenerate** from the **SKETCHER** menu.

If the sketch is fully dimensioned and constrained then the **Section regenerated successfully.** message is displayed in the **Message Area**. Figure 1-42 shows the completed sketch with dimensions and constraints.



Note

If Pro/ENGINEER detects that the sketch contains some extra dimensions that are not required then these extra dimensions are highlighted red in color. You need to delete these dimensions.

Saving the Sketch

Now, the sketch is finished and you need to save the sketch you have created.

1. Choose the **Save the active object** button from the **File** toolbar. The **Message Input Window** is displayed with C01TUT2-1.SEC, the name of the sketch. This is the name that you had entered earlier. 
2. Press ENTER. The sketch is saved.
3. Choose **SKETCHER > Done** from the **Menu Manager** to exit the sketcher environment.

Sketch Using the Intent Manager

The following steps outline the procedure for creating this sketch using the **Intent Manager**:

- a. Create a new object file.
- b. Draw the sketch using the tool button for creating lines.
- c. Dimension the required entities and then modify the dimensions of the sketch.
- d. Save the sketch.

Creating New Object File

Create a new object file and name it **c01tut2-2**. The procedure to create a new file is the same

as discussed earlier.

Drawing the Sketch

1. Choose the **Create lines.** button from the **Right Toolchest.** Using the left mouse button, select a point on the right of the graphics screen and start drawing horizontal line A. Here, you will notice that as you draw line A, **H** symbol is displayed on the line. This shows that the line drawn is horizontally constrained. Move the cursor towards left and specify the endpoint of the line. 
2. Move the cursor vertically upwards so that the **V** constraint appears on the line. When you get the appropriate size of the line, use the left mouse button to specify the endpoint of line B. Line B is completed.

Now, continue drawing the remaining lines that are shown in Figure 1-43. When the sketch is completed, end line creation by using the middle mouse button. You will notice that the sketched entities are dimensioned automatically as you draw them. These dimensions are weak dimensions and appear gray in color.

You do not need to trim the corners when you are using the **Intent Manager** because when you draw a line, the cursor snaps to the endpoint of the previous line. Hence, all the corners will be joined.



Dimensioning the Sketch

Weak dimensions are already applied to the sketch while drawing. You need to dimension only the angular dimension that is between lines D and E.

1. Choose the **Create defining dimension.** button. 
2. Select lines D and E using the left mouse button. The selected lines turn red in color. Now, using the middle mouse button, place the dimension close to the vertex where lines D and E join.



Applying the Constraints to the Sketch

Constraints are applied to the sketch to maintain the design intent of the feature and this might sometimes result in less dimensions in the sketch.

1. Choose **Impose sketcher constraints on the section.** button from the **Right Toolchest.** The **Constraints** dialog box is displayed. 
2. Choose the **Create Equal Lengths, Equal Radii, or Same Curvature constraint** button and select lines F and H. The equal length constraint L_2 is applied to both the lines. The constraint labels like L_2 or L_3 vary from sketch to sketch. 
3. Select lines C and K. The equal length constraint is applied to both the lines.
4. Now, select lines J and N. The equal length constraint is applied to both the lines.

5. Choose the **Make line or two vertices horizontal** button from the **Constraints** dialog box. You will be prompted to select a line or two vertices. 
6. Select the vertex that is joining lines L and M and the vertex that is joining lines G and H. Both the vertices are aligned horizontally as shown in Figure 1-43.

Modifying the Dimensions

1. Choose the **Select one item at a time - shift to gather more than one item.** button. 
2. Select all the dimensions using the SHIFT+left mouse button.
3. When all the dimensions turn red in color, choose the **Modify the values of dimensions, geometry of splines, or text entities.** button. The **Modify Dimensions** dialog box is displayed. 
4. Clear the **Regenerate** check box and then modify the values of the dimensions. When you clear this check box, the sketch is not regenerated as you modify the dimensions.

You will notice that the dimension you select in the **Modify Dimensions** dialog box is enclosed in a yellow box on the graphics screen.

5. When all the dimensions are modified, choose the **Regenerate the section and close the dialog** button from the **Modify Dimensions** dialog box. A message **Dimension modifications successfully completed.** is displayed in the **Message Area**. 

The completed sketch is shown in Figure 1-44. When you are sketching with **Intent Manager** on, the sketch is automatically regenerated after the dimensions are modified.

6. Save the sketch as discussed earlier. After saving the sketch, choose the **Continue with the current section.** button to exit the Sketch mode. 

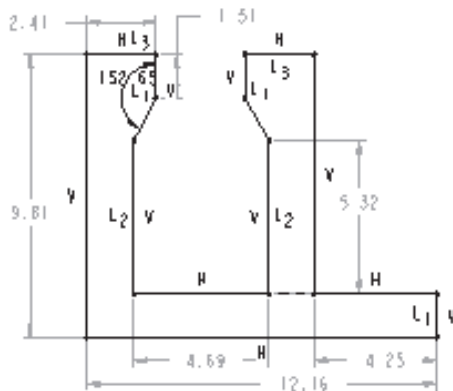

Figure 1-43 Sketch with weak dimensions and weak constraints

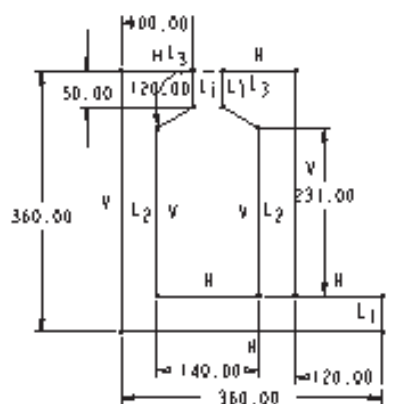

Figure 1-44 Completed sketch with dimensions and constraints

**Note**

You can modify dimensions individually when the **Intent Manager** is on. But, individual modification of dimension is recommended only when either there is minor change in the dimension value or when only one dimension is required to be modified.

Tutorial 3

In this tutorial you will draw the sketch shown in Figure 1-45. Draw the sketch both without using the **Intent Manager** and using the **Intent Manager**. For your reference, all the entities in the sketch are assigned alphabetical labels. **(Expected time: 30 min)**

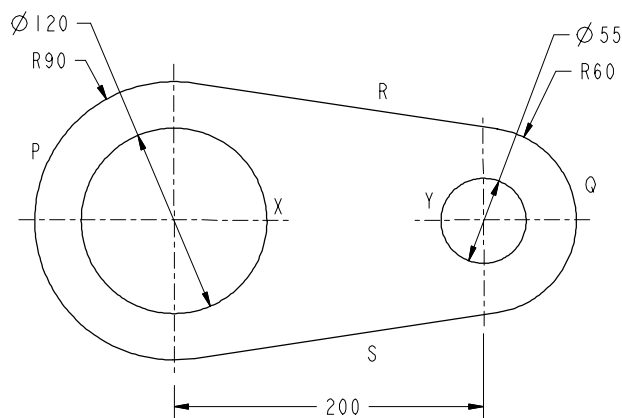

Figure 1-45 Sketch for Tutorial 3 with dimensions and labels for identification

Sketch Without Using the Intent Manager

The following steps outline the procedure for creating this sketch without using the **Intent Manager**:

- Set the working directory and create a new object file.
- Turn off the **Intent Manager** and draw the sketch using the sketcher options.
- Dimension the sketch and then modify the dimensions of the sketch.
- Regenerate the sketch.

Setting the Working Directory

The working directory was selected in Tutorial 1, therefore there is no need to select the working directory again. But if you still want to select the working directory, choose the **Set Working Directory** option from the **File** menu. The **Select Working Directory** dialog box is displayed. Set the working directory to **C:\ProE\c01**.

Creating New Object File

1. Choose the **Create a new object** button from the **File** toolbar. The **New** dialog box is displayed. Select the **Sketch** radio button from the **Type** area of the **New** dialog box. A default name of the sketch appears in the **Name** edit box. 
2. Enter **c01tut3-1** in the **Name** edit box. Choose the **OK** button.
3. You will enter the sketcher environment of the Sketch mode. When you enter the sketcher environment, the **Intent Manager** is on. To exit the **Intent Manager**, choose the **Intent Manager** option in the **Sketch** menu. The **Sketch** menu is available on the menu bar.

Drawing the Sketch

1. Choose the **Circle** option from the **GEOMETRY** submenu in the **Menu Manager**. The **CIRCLE TYPE** submenu is displayed with the **Geometry** and the **Center/Point** options selected by default. You are prompted to select the center of circle.
2. Sketch two circles P and Q some distance apart as shown in Figure 1-46.
3. Choose the **Concentric** option from the **CIRCLE TYPE** submenu. You will be prompted to select an arc.
4. Select circle P and using the left mouse button select a point inside circle P. A red rubber-band circle is attached to the cursor. Size the circle and complete it by using the left mouse button, see Figure 1-46.
5. Press the middle mouse button. Now, you are again prompted to select an arc.
6. Using the left mouse button, select circle Q. Use the left mouse button to select a point inside circle Q. A red rubber-band circle is attached to the cursor. Size the circle and complete it by using the left mouse button, see Figure 1-46.
7. Choose the **Line** option from the **GEOMETRY** submenu in the **Menu Manager**. The **LINE TYPE** submenu is displayed.
8. Choose the **2 Tangent** option from this submenu. Select circles P and Q on the circumference at the top of the circles. Tangent R is drawn, see Figure 1-47.
9. Similarly, draw tangent S to the circles as shown in Figure 1-47. These two tangents intersect the circles at the tangent points. The circles are now divided into two entities.
10. Delete the part of the circles that is not required by using the **Delete** option from the **SKETCHER** menu, see Figure 1-47.



Note

*If you draw the tangents using **2 Points** option then the circles will not be intersected and hence you cannot delete the part of the circle shown in the Figure 1-47.*

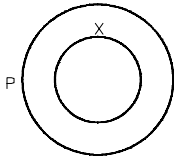

Figure 1-46 Two sets of circles in the sketch

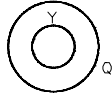

Figure 1-47 Tangent lines and the part of the circle to be deleted

Dimensioning the Sketch

In order to regenerate the sketch, it should be dimensioned.

1. Choose the **Dimension** option from the **SKETCHER** menu in the **Menu Manager**.
2. Using the left mouse button, select the left arc and use the middle mouse button to place the dimension as shown in Figure 1-48. The dimension appears as **sd0**.
3. Using the left mouse button, select circle X twice and place the dimension as shown in Figure 1-48. This dimension appears as **sd1**.
4. Using the left mouse button, select the right arc and use the middle mouse button to place the dimension. The dimension appears as **sd2**.
5. Using the left mouse button, select circle Y twice and place the dimension. This dimension appears as **sd3**.
6. Select the two centers of the circles and using the middle mouse button place the dimension. The dimension appears as **sd4**.

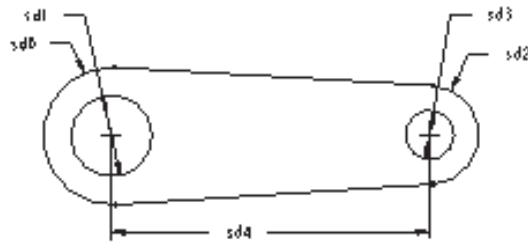

Figure 1-48 Dimensions of the sketch

Modifying the Dimensions

1. Choose the **Modify** option from the **SKETCHER** menu. The **MOD SKETCH** submenu is displayed. The **Mod Entity** option is selected by default.

2. Select the text **sd0**. The **Message Input Window** appears.
3. Enter a value of **90** in the **Message Input Window** and press ENTER.
4. Select the text **sd1**. The **Message Input Window** appears. Enter a value of **120** in this window and press ENTER.
5. Select the text **sd2**. The **Message Input Window** appears. Enter a value of **60** in this window and press ENTER.
6. Select the text **sd3**. The **Message Input Window** appears. Enter a value of **55** in this window and press ENTER.
7. Select the text **sd4**. The **Message Input Window** appears. Enter a value of **200** in this window and press ENTER.

Regenerating the Sketch

After all the dimension values are modified, you need to regenerate the sketch.

1. Choose **SKETCHER > Regenerate**. If the sketch is fully dimensioned and constrained the **Section regenerated successfully**, message is displayed in the **Message Area**.

The sketch after regeneration is shown in Figure 1-49.

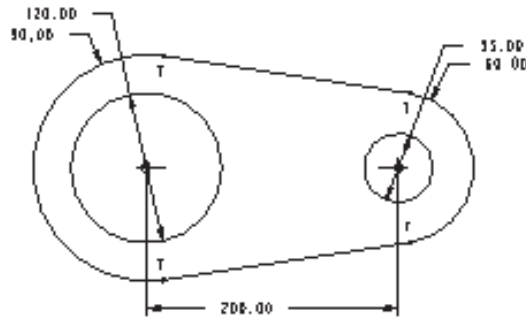

Figure 1-49 Sketch with dimensions and constraints

Saving the Sketch

You have to save the sketch because you may need the sketch later. This sketch is required in Tutorial 1 of Chapter 2.

1. Choose the **Save the active object** button from the **File** toolbar. The **Message Input Window** is displayed with the name of the sketch that you had entered while creating the file.
2. Press ENTER. The sketch is saved.
3. Choose the **Done** option to exit the Sketch mode.



Sketch Using the Intent Manager

The following steps outline the procedure for creating this sketch using the **Intent Manager**:

- a. Set the working directory and create a new object file.

- b. Draw the sketch using the sketcher tool buttons.
- c. Dimension the sketch and then modify the dimensions of the sketch.
- d. Save the sketch.

The steps **Setting the Working Directory** and **Creating New Object File** are the same as when you work without using the **Intent Manager**. When you create a new object file, the system takes you to the sketcher environment and the **Intent Manager** is on by default. In this method of sketching, the entities are dimensioned and constraints are applied automatically as you draw.

Create a new object file with the name **c01tut3-2**.

Drawing the Arcs

1. Choose the black arrow on the right of the **Create an arc by 3 points or tangent to an entity at its endpoint.** button to display the flyout. From this flyout, choose the **Create an arc by picking its center and endpoints.** button. 
2. Select the center of the left arc on the graphics screen, a temporary circle of varying size appears on the graphics screen.
3. Using the left mouse button, specify the start point of the arc and then specify the endpoint of the arc. The arc should extend more than a semicircle. You should note that when you specify the endpoint, the start point and the endpoint should lie vertically in the same line. For this purpose, a weak constraint is automatically applied. This arc is shown in Figure 1-50.
4. Similarly, create the right arc. The center of the two arcs should lie on the same horizontal line. This arc should be less than a semicircle. The start point and the endpoint of this arc should lie vertically on the same line. This arc is shown in Figure 1-50.

Drawing the Lines

1. Choose the **Create lines.** button. Draw the two lines that connects the two arcs. 
2. After both the lines are drawn, press the middle mouse button to end line creation. Some weak dimensions and constraints are applied to the sketch as shown in Figure 1-51.

Applying Constraints

As evident from Figure 1-51, the tangent constraints are applied automatically to some points. You will apply the tangent constraint to the sketch where required. The tangent constraint is denoted by symbol **T** on the graphics screen. You should note that if some constraint is already applied to a point while sketching and you apply some other constraint on the same point then the **Resolve Sketch** dialog box is displayed. This dialog box lists all the constraints that are conflicting. Using this dialog box you can either undo the constraint you applied or select a constraint from the list and choose the **DELETE** button.



Figure 1-50 The two arcs with weak dimensions and constraints

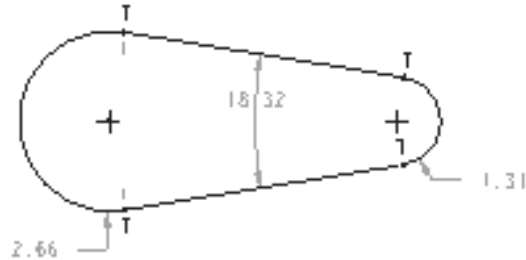





Figure 1-51 Arcs joined by lines and the tangent constraint is automatically applied

1. Choose the **Impose sketcher constraints on the section.** button. The **Constraints** dialog box is displayed. 
2. Choose the **Make two entities tangent** button from the dialog box. 
3. Select line R and arc Q. The tangent constraint is applied to the line and the arc. If the constraint is already applied, the **Resolve Sketch** dialog box will be displayed. Choose the **Undo** button from this dialog box to undo the constraint.
4. Similarly, select line S and arc Q to apply the constraint. Then select line R and arc P to apply the constraint and then select line S and arc P.

Drawing the Circles

1. Choose the black arrow on the right of the **Create circle by picking the center and a point on the circle.** button to display the flyout. From this flyout, choose the **Create concentric circle.** button. You will be prompted to select an arc. 
2. Select arc P and create circle X concentric to the arc. Similarly, select arc Q to create circle Y.

Dimensioning the Sketch

1. Choose the **Create defining dimension.** button. 
2. Select the center of two circles and place the dimension at the bottom of the sketch.

Modifying the Dimensions

1. Choose the **Select one item at a time - shift to gather more than one item.** button. 
2. Select all the dimensions using the SHIFT+left mouse button.

Faculty evaluation copy. Do not reproduce. For information visit www.cadcam.com

**Note**

You can also use **CTRL+ALT+A** from the keyboard to select all the entities and items in the sketch.

- When all the dimensions turn red in color, choose the **Modify the values of dimensions, geometry of splines, or text entities.** button. The **Modify Dimensions** dialog box is displayed. 

- Clear the **Regenerate** check box and then modify the values of the dimensions.

You will notice, that the dimension you edit in the **Modify Dimensions** dialog box is enclosed by a yellow box dimension on the graphics screen.

- When all the dimensions are modified, choose the **Regenerate the section and close the dialog** button from the **Modify Dimensions** dialog box. A message **Dimension modifications successfully completed.** is displayed in the **Message Area**. 

The sketch is completed and is shown in Figure 1-52.

- Save the sketch as discussed earlier. After saving the sketch, choose the **Continue with the current section.** button to exit the Sketch mode. 

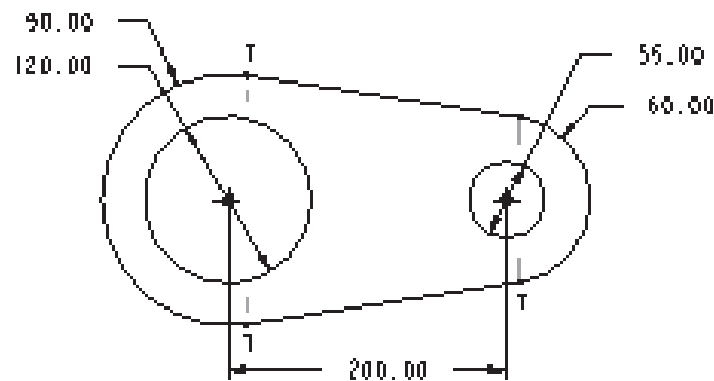

Figure 1-52 Sketch with dimensions and constraints

Self-Evaluation Test

Answer the following questions and then compare your answers to the answers given at the end of this chapter.

1. The sketch considers the default sketch constraints when working with the **Intent Manager** kept off. (T/F)
2. While working in the Sketch mode of Pro/ENGINEER the section sketch need not be a closed loop for successful regeneration. (T/F)
3. If the **Intent Manager** is on and you draw a line then the cursor snaps to the endpoint of the previous line. (T/F)
4. When you are in the middle of sketch creation you cannot turn on the **Intent Manager**. (T/F)
5. The options available in the **LINE TYPE** submenu are different when you select **Geometry** and **Centerline** individually. (T/F)
6. The _____ submenu has the **Mirror** option in it.
7. _____ controls the design intent of a model.
8. **Intent Manager** is _____ by default when you enter the Sketch mode.
9. For the Sketch mode the symbolic dimension is represented by _____ symbol.
10. The Sketch mode file is saved as _____ file extension.

Review Questions

Answer the following questions:

1. What is the need of Sketch mode in Pro/ENGINEER?
2. What are the four basic steps to create a sketch?
3. What are the different types of line types you can sketch using the **Line** option?
4. Why is it important to select the working directory before creating a new file?
5. Write all the steps involved in successful regeneration of a sketch when the **Intent Manager** is off.
6. Relations can be added in the Sketch mode. (T/F)

7. You can use the **Create rectangle.** button from the **Right Toolchest** to draw a square. (T/F)
8. The _____ button is used to exit the sketcher environment. (T/F)
9. You cannot undo a previous operation in the sketcher environment. (T/F)
10. You can also use the options to draw a sketch from the **Sketch** menu in the menu bar. (T/F)

Exercises

Exercise 1

Create the sketch as shown in Figure 1-53 using the **Intent Manager** and without using the **Intent Manager**.

(Expected time: 30 min)

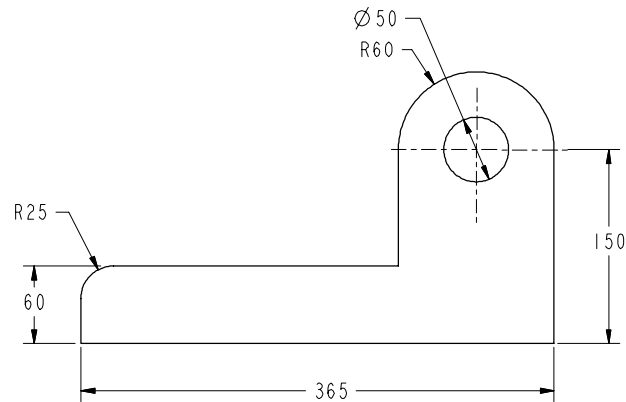

Figure 1-53 Figure for Exercise 1

Exercise 2

Create the sketch shown in Figure 1-54 using the **Intent Manager** and without using the **Intent Manager**.

(Expected time: 30 min)

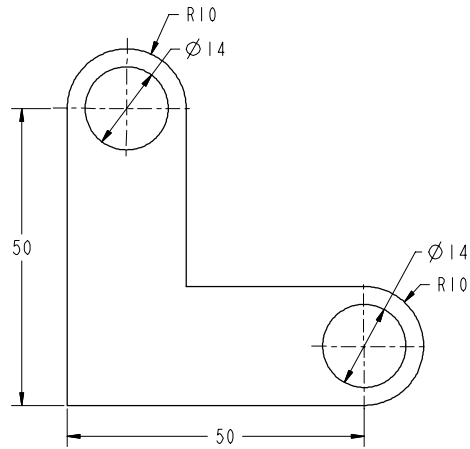

Figure 1-54 Figure for Exercise 2

Exercise 3

Create the sketch as shown in Figure 1-55 using the **Intent Manager**.

(Expected time: 30 min)

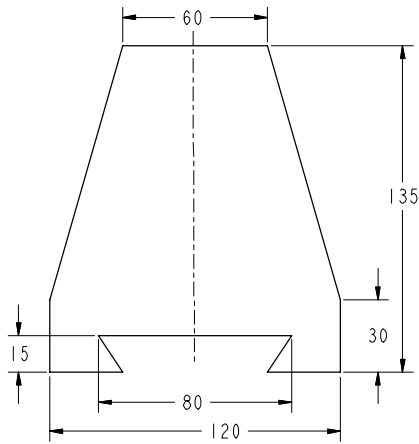

Figure 1-55 Figure for Exercise 3

Exercise 4

Create the sketch as shown in Figure 1-56 using the **Intent Manager**.

(Expected time: 30 min)

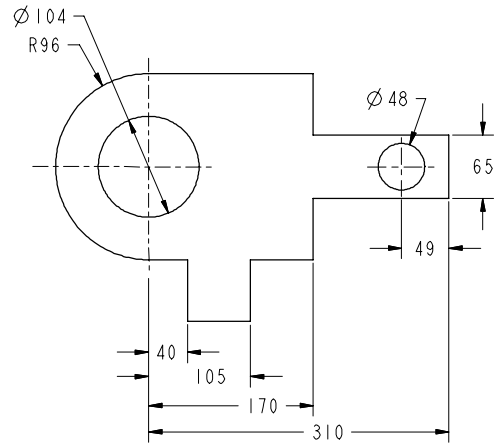

Figure 1-56 Figure for Exercise 4

Answers to Self-Evaluation Test

1 - T, 2 - T, 3 - T, 4 - T, 5 - F, 6 - GEOM TOOLS, 7 - Intent Manager, 8 - on, 9 - sd, 10 - .sec